

Kit Contents:

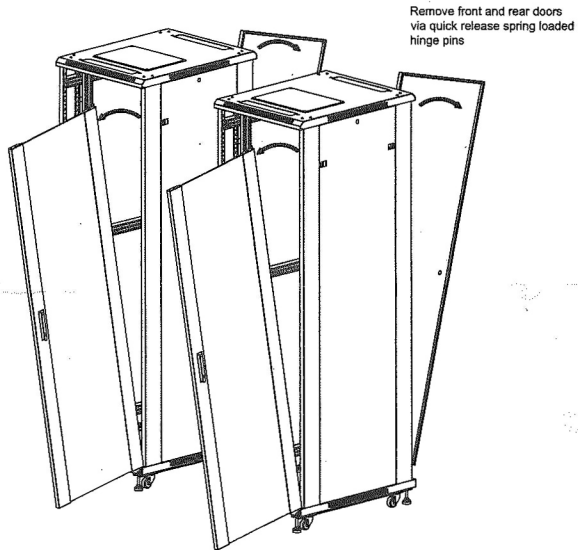

Remove front and rear doors via quick release spring loaded hinge pins

a

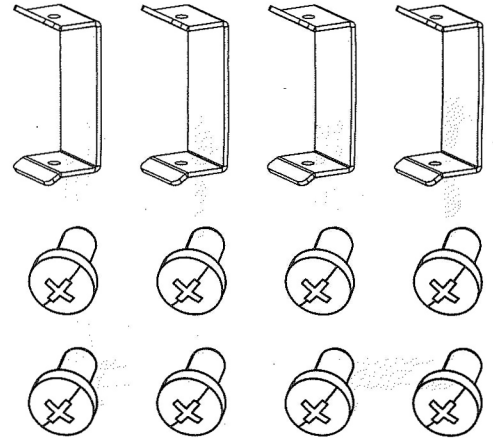

Move racks together until sides are touching.

b

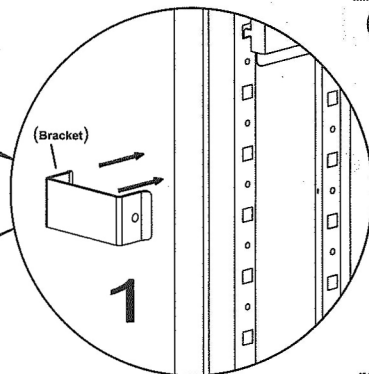
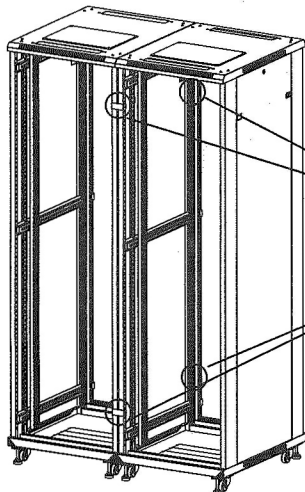

(Bracket)

1

IMPORTANT



Make sure both racks are level with each other.

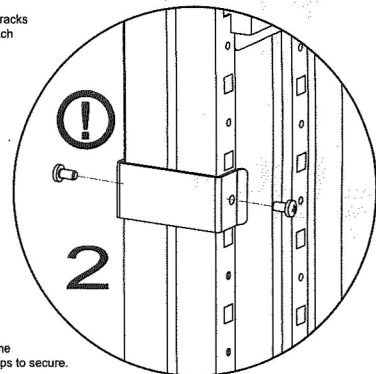

2

c

Fit 4 (brackets) into frame slots. Press down on clips to secure.

IMPORTANT



Make sure all 4 bracket are fully engaged. Secure each bracket with two M5x10 self tapping screws

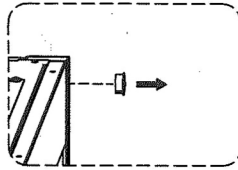
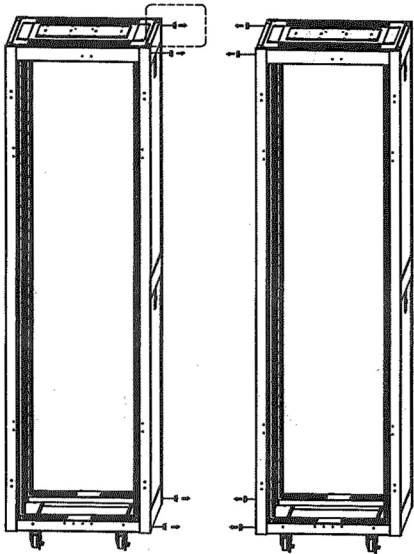

Remove the plastic cover at top of rack side the rack (8 pcs).

Note:
Remove front and rear doors by opening and simply lifting of the hinge pin assembly!

 x 8 **1**

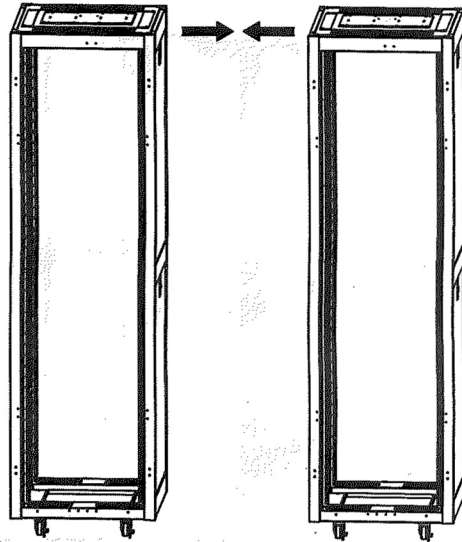

Move racks together until sides are touching

2

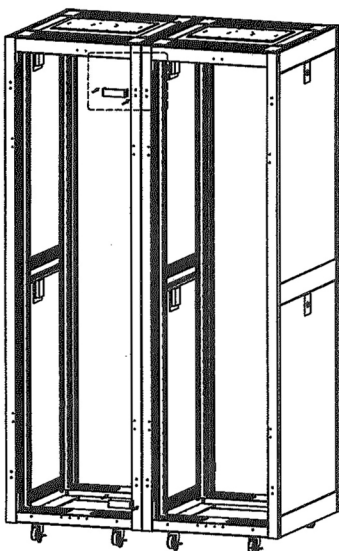
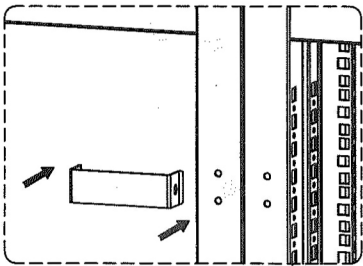

Fix the bracket to the top and bottom of the front and rear rack frame posts .

 x 4 **3**

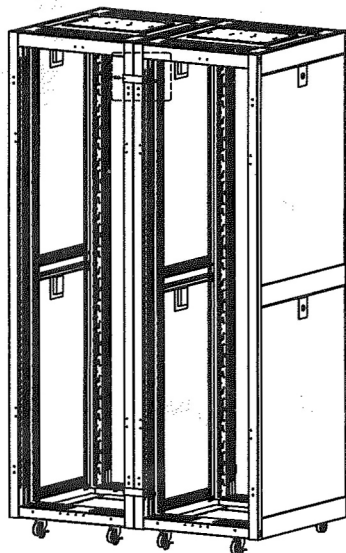
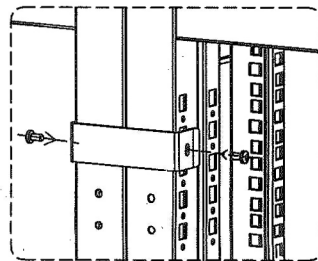

Secure each bracket with two M5X10 Self-tapping screws

 x 8 **4**

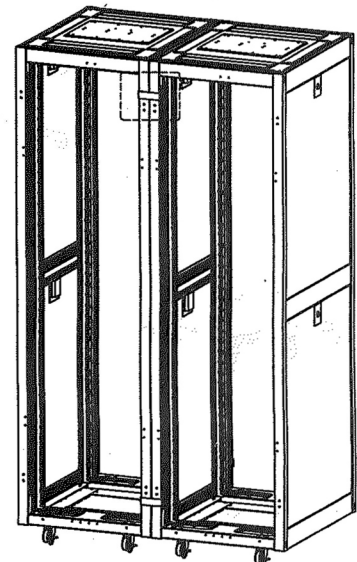
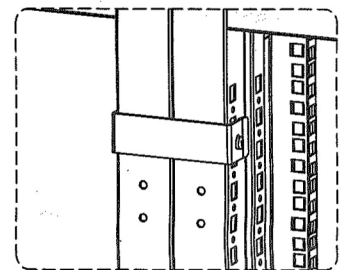

Baying is Complete

5