

# UPS Network Management Card

## Network-M2 User's Guide

English



11/18/2019

1.7.4

# **EATON**

*Powering Business Worldwide*



Eaton is a registered trademark of Eaton Corporation or its subsidiaries and affiliates.

Phillips and Pozidriv are a registered trademarks of Phillips Screw Company.

National Electrical Code and NEC are registered trademarks of National Fire Protection Association, Inc.

Microsoft®, Windows®, and Windows Server® are either registered trademarks or trademarks of Microsoft Corporation in the United States and/or other countries.

UNIX® is a registered trademark of The Open Group.

Linux® is the registered trademark of Linus Torvalds in the U.S. and other countries.

VMware is a registered trademark or trademark of VMware, Inc. in the United States and/or other jurisdictions.

Google™ is a trademark of Google Inc.

All other trademarks are properties of their respective companies.

©Copyright 2019 Eaton Corporation. All rights reserved.

No part of this document may be reproduced in any way without the express written approval of Eaton Corporation.

# 1 Table of Contents

1	TABLE OF CONTENTS .....	4
2	CONTEXTUAL HELP .....	13
2.1	Login page .....	13
2.1.1	Logging in for the first time .....	13
2.1.2	Troubleshooting login issues .....	13
2.2	Home.....	13
2.2.1	Menu structure.....	14
2.2.2	Energy flow diagram.....	16
2.2.2.1	Line interactive .....	16
2.2.2.2	Online .....	18
2.2.3	Top bar.....	20
2.2.4	Details.....	21
2.2.5	Show measures.....	21
2.2.5.1	Example #1 .....	21
2.2.5.2	Example #2.....	21
2.2.6	Outlet status.....	21
2.2.7	Active Alarms .....	22
2.3	Alarms .....	22
2.3.1	Alarm sorting .....	22
2.3.2	Alarm details.....	22
2.3.3	Alarm paging.....	22
2.3.4	Alarm export.....	23
2.3.5	Clear alarm logs .....	23
2.3.6	Alarm list with codes .....	23
2.4	Settings .....	23
2.4.1	General .....	23
2.4.1.1	Location .....	23
2.4.1.2	Contact .....	24
2.4.1.3	System name .....	24
2.4.1.4	Default settings parameters and limitations.....	24
2.4.2	Date & Time .....	24
2.4.2.1	Manual: Manually entering the date and time .....	24
2.4.2.2	Dynamic (NTP): Synchronizing the date and time with an NTP server .....	24
2.4.2.3	Default settings parameters and limitations.....	25
2.4.3	Users .....	25
2.4.3.1	Password strength rules.....	25
2.4.3.2	Account expiration.....	25
2.4.3.3	Session expiration .....	26
2.4.3.4	Local users table.....	26
2.4.3.5	LDAP .....	29
2.4.3.6	RADIUS .....	32
2.4.3.7	Default settings parameters and limitations.....	35
2.4.4	Network.....	35
2.4.4.1	LAN.....	35
2.4.4.2	IPv4.....	35
2.4.4.3	Domain .....	37
2.4.4.4	IPv6.....	38
2.4.4.5	Default settings parameters and limitations.....	40

2.4.5	Protocols.....	40
2.4.5.1	HTTPS.....	40
2.4.5.2	Syslog.....	40
2.4.5.3	Default settings parameters and limitations.....	41
2.4.6	SNMP.....	41
2.4.6.1	SNMP tables.....	42
2.4.6.2	Trap receivers.....	44
2.4.6.3	Actions.....	45
2.4.6.4	Default settings parameters and limitations.....	46
2.4.7	Certificates.....	46
2.4.7.1	Local certificates.....	46
2.4.7.2	Certificate authorities (CA).....	48
2.4.7.3	Pairing with clients.....	49
2.4.7.4	Trusted remote certificates.....	50
2.4.7.5	Default settings parameters and limitations.....	50
2.4.8	Email.....	50
2.4.8.1	Email sending configuration.....	50
2.4.8.2	Default settings parameters and limitations.....	53
2.4.9	My preferences.....	53
2.4.9.1	Profile.....	54
2.4.9.2	Temperature.....	54
2.4.9.3	Date format.....	55
2.4.9.4	Time format.....	55
2.4.9.5	Language.....	56
2.4.9.6	Default settings parameters and limitations.....	56
2.5	Meters.....	56
2.5.1	Power.....	56
2.5.1.1	Input.....	56
2.5.1.2	Output.....	57
2.5.2	Battery.....	57
2.5.2.1	Overview.....	57
2.5.2.2	Details.....	57
2.5.2.3	Test.....	57
2.5.3	Measure logs.....	58
2.5.3.1	Configuration.....	58
2.5.3.2	Measure logs.....	58
2.5.3.3	Default settings parameters and limitations.....	59
2.6	Controls.....	59
2.6.1	UPS.....	59
2.6.1.1	Entire UPS.....	59
2.6.2	Outlets.....	60
2.6.2.1	Group 1/ Group 2.....	60
2.7	Protection.....	61
2.7.1	Scheduled shutdowns.....	61
2.7.1.1	Scheduled shutdowns table.....	61
2.7.1.2	Actions.....	61
2.7.2	Agent list.....	62
2.7.2.1	Pairing with shutdown agents.....	62
2.7.2.2	Agent list table.....	62
2.7.2.3	Actions.....	63
2.7.3	Agent settings.....	63
2.7.3.1	Agent shutdown sequence timing.....	63
2.7.3.2	Actions.....	64
2.7.3.3	Examples.....	64

2.7.4	Power outage policy .....	64
2.7.4.1	On power outage.....	65
2.7.4.2	On low battery warning.....	69
2.7.4.3	When utility comes back .....	70
2.8	Card .....	70
2.8.1	System information .....	70
2.8.1.1	Identification .....	70
2.8.1.2	Firmware information .....	71
2.8.2	Resources.....	71
2.8.2.1	Processor.....	71
2.8.2.2	Memory.....	71
2.8.2.3	Storage .....	72
2.8.3	System logs.....	72
2.8.4	Administration .....	73
2.8.4.1	Network module firmware .....	73
2.8.4.2	Sanitization .....	74
2.8.4.3	Reboot.....	75
2.8.4.4	Maintenance.....	75
2.8.4.5	Settings .....	76
2.8.5	Commissioning (sensors) .....	78
2.8.5.1	Sensors commissioning table.....	78
2.8.5.2	Actions.....	78
2.8.5.3	Note:.....	81
2.9	Sensors.....	81
2.9.1	Status (sensors).....	81
2.9.1.1	Temperature table .....	81
2.9.1.2	Humidity table .....	81
2.9.1.3	Dry contacts table.....	82
2.9.2	Alarm configuration (sensors).....	82
2.9.2.1	Temperature .....	82
2.9.2.2	Humidity .....	83
2.9.2.3	Dry contacts .....	84
2.9.2.4	Default settings parameters and limitations.....	84
2.9.3	Information (sensors).....	84
2.10	Legal information (footer) .....	85
2.10.1	Component list .....	85
2.10.2	Notice for our proprietary (i.e. non-Open source) elements.....	85
2.10.3	Availability of source code.....	86
2.11	Contextual help and full documentation .....	86
2.11.1	Access to contextual help .....	86
2.11.2	Access to full documentation.....	86
<b>3</b>	<b>SERVICING THE NETWORK MANAGEMENT MODULE .....</b>	<b>88</b>
3.1	Unpacking the Network module.....	88
3.2	Installing the Network Module .....	88
3.2.1	Mounting the Network Module.....	88
3.3	Accessing the Network Module.....	88
3.3.1	Accessing the web interface through Network.....	88
3.3.1.1	Connecting the network cable.....	88
3.3.1.2	Accessing the web interface .....	89
3.3.2	Finding and setting the IP address .....	89
3.3.2.1	Your network is equipped with a BOOTP/DHCP server (default).....	89
3.3.2.2	Your network is not equipped with a BOOTP/DHCP server.....	89
3.3.3	Accessing the web interface through RNDIS.....	90

3.3.3.1	Connecting the configuration cable.....	90
3.3.3.2	Web interface access through RNDIS.....	90
3.3.4	Accessing the card through serial terminal emulation.....	92
3.3.4.1	Connecting the configuration cable.....	92
3.3.4.2	Manual configuration of the serial connection.....	93
3.3.4.3	Accessing the card through Serial.....	94
3.3.5	Modifying the Proxy exception list.....	94
3.4	Configuring the Network Module settings.....	96
3.5	Configuring/Commissioning/Testing LDAP.....	97
3.5.1	Commissioning.....	97
3.5.1.1	Configuring connection to LDAP database.....	97
3.5.1.2	Testing connection to LDAP database.....	97
3.5.1.3	Map remote users to profile.....	98
3.5.1.4	Testing profile mapping.....	98
3.5.1.5	Define LDAP user's preferences.....	98
3.5.2	Testing LDAP authentication.....	98
3.5.3	Limitations.....	98
3.6	Pairing agent to the Network Module.....	98
3.6.1	Pairing with credentials on the agent.....	99
3.6.2	Pairing with automatic acceptance (recommended if done in a secure and trusted network).....	99
3.6.3	Pairing with manual acceptance.....	99
3.7	Powering down/up applications (examples).....	100
3.7.1	Powering down IT system in a specific order.....	100
3.7.1.1	Target.....	100
3.7.1.2	Step 1: Installation setup.....	100
3.7.1.3	Step 2: Agent settings.....	101
3.7.1.4	Step 3: Power outage policy settings.....	101
3.7.2	Powering down non-priority equipment first.....	102
3.7.2.1	Target.....	102
3.7.2.2	Step 1: Installation setup.....	103
3.7.2.3	Step 2: Agent settings.....	103
3.7.2.4	Step 3: Power outage policy settings.....	104
3.7.3	Restart sequentially the IT equipment on utility recovery.....	105
3.7.3.1	Target.....	105
3.7.3.2	Step 1: Installation setup.....	106
3.7.3.3	Step 2: Power outage policy settings.....	106
3.8	Checking the current firmware version of the Network Module.....	107
3.9	Accessing to the latest Network Module firmware/driver/script.....	107
3.10	Upgrading the card firmware (Web interface / shell script).....	107
3.10.1	Web interface.....	107
3.10.2	Shell script.....	107
3.10.2.1	Prerequisite.....	107
3.10.2.2	Procedure.....	107
3.10.3	Example:.....	108
3.11	Changing the RTC battery cell.....	108
3.12	Updating the time of the Network Module precisely and permanently (ntp server).....	110
3.13	Synchronizing the time of the Network Module and the UPS.....	110
3.13.1	Automatic time synchronization.....	110
3.13.1.1	Every day at 5 a.m.....	110
3.13.1.2	If the Network Module time is lost.....	110
3.13.2	Manual time synchronization.....	110
3.13.2.1	From the Network Module.....	110
3.13.2.2	From the UPS.....	110
3.14	Changing the language of the web pages.....	110

3.15	Resetting username and password.....	111
3.15.1	As an admin for other users .....	111
3.15.2	Resetting its own password.....	111
3.16	Recovering main administrator password .....	111
3.17	Switching to static IP (Manual) / Changing IP address of the Network Module.....	112
3.18	Reading product (UPS) information in a simple way .....	112
3.18.1	Web page .....	112
3.19	Subscribing to a set of alarms for email notification.....	113
3.19.1	Example #1: subscribing only to one alarm (load unprotected).....	113
3.19.2	Example #2: subscribing to all Critical alarms and some specific Warnings .....	115
3.20	Saving/Restoring/Duplicating Network module configuration settings .....	117
3.20.1	Modifying the JSON configuration settings file.....	117
3.20.1.1	JSON file structure .....	117
3.20.1.2	Sensitive data (like passwords) .....	118
3.20.1.3	Modifying JSON file examples .....	119
3.20.1.4	Non-intuitive data values in the JSON file .....	121
3.20.2	Saving/Restoring/Duplicating settings through the CLI.....	124
3.20.3	Saving/Restoring/Duplicating settings through the Web interface.....	124
<b>4</b>	<b>SECURING THE NETWORK MANAGEMENT MODULE.....</b>	<b>125</b>
4.1	Cybersecurity considerations for electrical distribution systems .....	125
4.1.1	Purpose .....	125
4.1.2	Introduction .....	125
4.1.3	Connectivity—why do we need to address cybersecurity for industrial control systems (ICS)? .....	125
4.1.4	Cybersecurity threat vectors .....	125
4.1.4.1	Paths to the control network.....	126
4.1.5	Defense in depth.....	126
4.1.6	Designing for the threat vectors.....	127
4.1.6.1	Firewalls .....	127
4.1.6.2	Demilitarized zones (DMZ) .....	127
4.1.6.3	Intrusion detection and prevention systems (IDPS) .....	129
4.1.7	Policies, procedures, standards, and guidelines.....	129
4.1.7.1	Understanding an ICS network.....	129
4.1.7.2	Log and event management.....	129
4.1.7.3	Security policy and procedures.....	130
4.1.7.4	ICS hardening .....	130
4.1.7.5	Continuous assessment and security training.....	130
4.1.7.6	Patch management planning and procedures .....	131
4.1.8	Conclusion .....	131
4.1.9	Terms and definitions .....	131
4.1.10	Acronyms .....	131
4.1.11	References .....	132
4.2	Cybersecurity recommended secure hardening guidelines .....	133
4.2.1	Introduction .....	133
4.2.2	Secure configuration guidelines .....	133
4.2.2.1	Asset identification and Inventory .....	133
4.2.2.2	Physical Protection .....	134
4.2.2.3	Authorization and Access Control.....	134
4.2.2.4	Deactivate unused features.....	135
4.2.2.5	Logging and Event Management .....	136
4.2.2.6	Secure Maintenance.....	136
4.2.3	References .....	136
4.3	Configuring user permissions through profiles.....	137
4.4	Decommissioning the Network Management module .....	137



<b>5</b>	<b>SERVICING THE EMP</b> .....	138
5.1	Description and features .....	138
5.2	Unpacking the EMP .....	138
5.3	Installing the EMP .....	139
5.3.1	Defining EMPs address and termination .....	139
5.3.1.1	Manual addressing .....	139
5.3.2	Mounting the EMP .....	139
5.3.2.1	Rack mounting with keyhole example.....	140
5.3.2.2	Rack mounting with tie wraps example .....	140
5.3.2.3	Wall mounting with screws example .....	141
5.3.2.4	Wall mounting with nylon fastener example.....	141
5.3.3	Cabling the first EMP to the device.....	142
5.3.3.1	Available Devices.....	142
5.3.3.2	Connecting the EMP to the device.....	142
5.3.4	Daisy chaining EMPs .....	143
5.3.4.1	Material needed:.....	143
5.3.4.2	Steps .....	144
5.3.5	Connecting an external contact device.....	144
5.4	Commissioning the EMP .....	144
5.4.1	On the Network-M2 device .....	144
5.5	Using the EMP for temperature compensated battery charging.....	145
5.5.1	Addressing the EMP.....	145
5.5.2	Commissioning the EMP.....	146
5.5.3	Enabling temperature compensated battery charging in the UPS.....	146
<b>6</b>	<b>INFORMATION</b> .....	147
6.1	Front panel connectors and LED indicators .....	147
6.2	Default settings and possible parameters .....	148
6.2.1	Settings .....	148
6.2.1.1	General .....	148
6.2.1.2	Date & Time .....	148
6.2.1.3	Users .....	148
6.2.1.4	Network.....	151
6.2.1.5	Protocols.....	151
6.2.1.6	SNMP .....	152
6.2.1.7	Certificate .....	153
6.2.1.8	Email.....	154
6.2.1.9	My preferences .....	154
6.2.2	Meters .....	155
6.2.3	Sensors alarm configuration .....	155
6.3	Specifications/Technical characteristics .....	156
6.4	List of event codes .....	156
6.5	Alarm log codes .....	156
6.5.1	Critical.....	157
6.5.2	Warning .....	158
6.5.3	Info .....	160
6.5.4	With settable severity.....	161
6.6	System log codes .....	162
6.6.1	Critical.....	162
6.6.2	Warning .....	162
6.6.3	Info .....	163
6.7	SNMP traps .....	165
6.7.1	Sensor Mib traps .....	165

6.7.2	Xups Mib traps .....	165
6.7.3	IETF Mib-2 Ups traps .....	166
6.8	CLI .....	166
6.8.1	Commands available .....	167
6.8.2	Contextual help .....	167
6.8.3	get release info .....	168
6.8.3.1	Description .....	168
6.8.3.2	Access .....	168
6.8.3.3	Help .....	168
6.8.4	history .....	168
6.8.4.1	Description .....	168
6.8.4.2	Access .....	168
6.8.4.3	Help .....	168
6.8.5	ldap-test .....	168
6.8.5.1	Description .....	168
6.8.5.2	Access .....	169
6.8.5.3	Help .....	169
6.8.6	logout .....	169
6.8.6.1	Description .....	169
6.8.6.2	Access .....	170
6.8.6.3	Help .....	170
6.8.7	maintenance .....	170
6.8.7.1	Description .....	170
6.8.7.2	Access .....	170
6.8.7.3	Help .....	170
6.8.8	netconf .....	170
6.8.8.1	Description .....	170
6.8.8.2	Access .....	170
6.8.8.3	Help .....	170
6.8.8.4	Examples of usage .....	173
6.8.9	ping and ping6 .....	173
6.8.9.1	Description .....	173
6.8.9.2	Access .....	173
6.8.9.3	Help .....	173
6.8.10	reboot .....	173
6.8.10.1	Description .....	173
6.8.10.2	Access .....	174
6.8.10.3	Help .....	174
6.8.11	save_configuration   restore_configuration .....	174
6.8.11.1	Description .....	174
6.8.11.2	Access .....	174
6.8.11.3	Help .....	174
6.8.11.4	Examples of usage .....	174
6.8.12	sanitize .....	175
6.8.12.1	Description .....	175
6.8.12.2	Access .....	175
6.8.12.3	Help .....	175
6.8.13	ssh-keygen .....	175
6.8.13.1	Description .....	175
6.8.13.2	Access .....	175
6.8.13.3	Help .....	175
6.8.14	time .....	175
6.8.14.1	Description .....	175
6.8.14.2	Access .....	175

6.8.14.3	Help .....	175
6.8.14.4	Examples of usage .....	176
6.8.15	traceroute and traceroute6 .....	176
6.8.15.1	Description .....	176
6.8.15.2	Access .....	176
6.8.15.3	Help .....	176
6.8.16	whoami .....	177
6.8.16.1	Description .....	177
6.8.16.2	Access .....	177
6.8.17	email-test .....	177
6.8.17.1	Description .....	177
6.8.17.2	Access .....	177
6.8.17.3	Help .....	177
6.8.18	systeminfo_statistics .....	177
6.8.18.1	Description .....	177
6.8.18.2	Access .....	178
6.8.18.3	Help .....	178
6.8.19	certificates .....	178
6.8.19.1	Description .....	178
6.8.19.2	Access .....	178
6.8.19.3	Help .....	178
6.8.19.4	Examples of usage .....	179
6.9	Legal information .....	179
6.9.1	Availability of Source Code .....	179
6.9.2	Notice for Open Source Elements .....	179
6.9.3	Notice for our proprietary (i.e. non-Open source) elements .....	180
6.10	Acronyms and abbreviations .....	181
<b>7</b>	<b>TROUBLESHOOTING .....</b>	<b>184</b>
7.1	Action not allowed in Control/Schedule/Power outage policy .....	184
7.1.1	Symptom .....	184
7.1.2	Possible Cause .....	184
7.1.3	Action .....	184
7.2	Client server is not restarting .....	184
7.2.1	Symptom .....	184
7.2.2	Possible Cause .....	184
7.2.3	Action .....	184
7.3	EMP detection fails at discovery stage .....	184
7.3.1	Symptom #1 .....	184
7.3.1.1	Possible causes .....	184
7.3.1.2	Action #1-1 .....	185
7.3.1.3	Action #1-2 .....	185
7.3.1.4	Action #1-3 .....	185
7.3.2	Symptom #2 .....	185
7.3.2.1	Possible causes .....	185
7.3.2.2	Action #2-1 .....	185
7.3.2.3	Action #2-2 .....	185
7.4	How do I log in if I forgot my password? .....	185
7.4.1	Action .....	185
7.5	Card wrong timestamp leads to "Full acquisition has failed" error message on IPM/IPP .....	186
7.5.1	Symptoms: .....	186
7.5.2	Possible cause: .....	186
7.5.3	Action: .....	186
7.6	IPP/IPM is not able to communicate with the Network module .....	186

7.6.1	Symptoms .....	186
7.6.2	Possible cause .....	186
7.6.3	Setup .....	186
7.6.4	Action #1 .....	186
7.6.5	Action #2 .....	187
7.7	LDAP configuration/commissioning is not working .....	187
7.8	Password change in My preferences is not working .....	187
7.8.1	Symptoms .....	187
7.8.2	Possible cause .....	187
7.8.3	Action .....	187
7.9	SNMPv3 password management issue with Save and Restore .....	188
7.9.1	Affected FW versions .....	188
7.9.2	Symptom .....	188
7.9.3	Cause .....	188
7.9.4	Action .....	188
7.10	The Network Module fails to boot after upgrading the firmware .....	188
7.10.1	Possible Cause .....	188
7.10.2	Action .....	188
7.11	Web user interface is not up to date after a FW upgrade .....	188
7.11.1	Symptom .....	188
7.11.1.1	Possible causes .....	188
7.11.1.2	Action .....	188

## 2 Contextual Help

### 2.1 Login page

**EATON**  
Powering Business Worldwide

Nom d'utilisateur

Mot de passe

Mot de passe oublié ?

Connexion

**Utilisation appropriée :**

- (a) vous accédez à un système privé ou gouvernemental.
- (b) ce système peut être surveillé, enregistré et soumis à vérification.
- (c) l'utilisation non autorisée de ce système est interdite et soumise à des sanctions pénales et civiles.
- (d) l'utilisation de ce système indique le consentement à la surveillance et à l'enregistrement.

The page language is set to English by default but can be switched to browser language when it is managed. After navigating to the assigned IP address, accept the untrusted certificate on the browser.

#### 2.1.1 Logging in for the first time

##### 1. Enter default password

As you are logging into the Network Module for the first time you must enter the factory set default username and password.

- Username = admin
- Password = admin

##### 2. Change default password

Changing the default password is mandatory and requested in a dedicated window.

Enter your current password first, and then enter the new password twice.

Follow the password format recommendations on the tooltip in order to define a secure password.

##### 3. Accept license agreement

On the next step, License Agreement is displayed.

Read and accept the agreement to continue.

#### 2.1.2 Troubleshooting login issues



For details on troubleshooting, see the *Troubleshooting* section.

## 2.2 Home

The Home screen provides status information for the device including synoptic diagrams, key measures and active alarms.

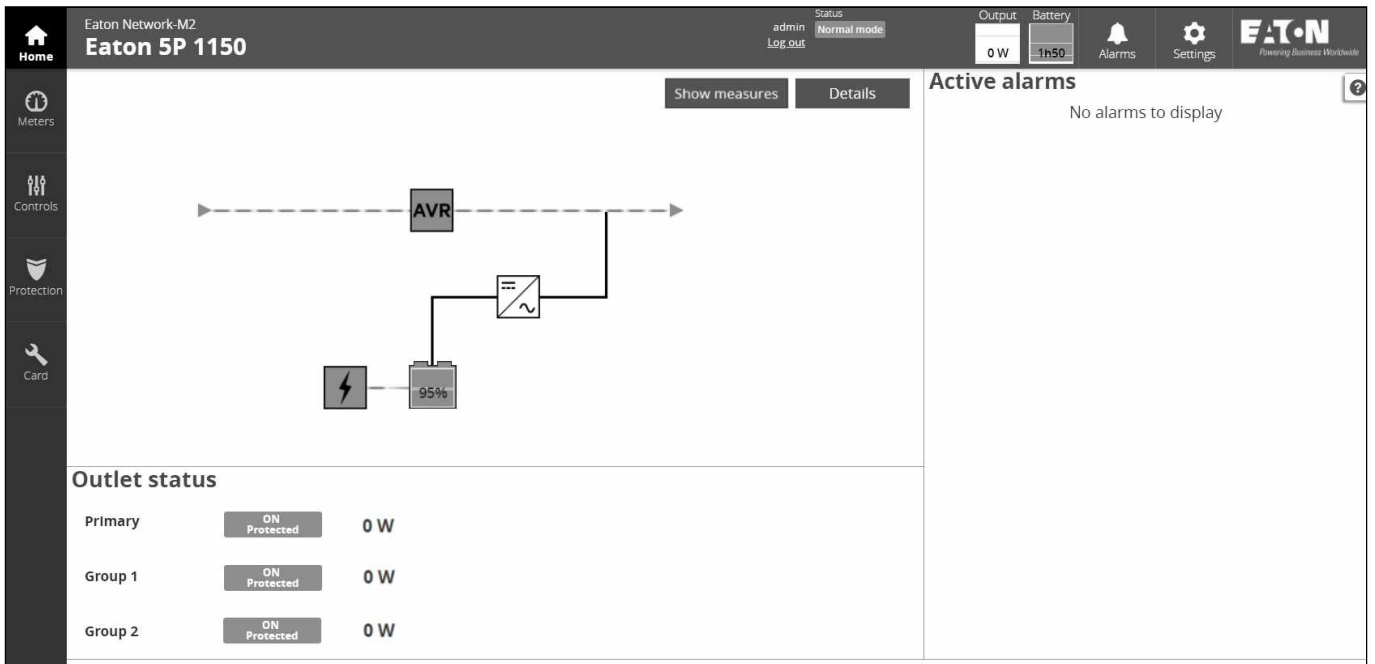

## 2.2.1 Menu structure

Button	Description
Home	<p>Overview and status of UPS Module:</p> <ul style="list-style-type: none"> <li>• Synoptic</li> <li>• Active alarms</li> <li>• Outlet status</li> </ul>
Settings	<p>Module settings:</p> <ul style="list-style-type: none"> <li>• General</li> <li>• Date &amp; Time</li> <li>• Users</li> <li>• Network</li> <li>• Protocols</li> <li>• SNMP</li> <li>• Certificates</li> <li>• Email</li> <li>• My preferences</li> </ul>
Alarms	<p>List of alarms with date and time:</p> <ul style="list-style-type: none"> <li>• Details</li> <li>• Clear</li> <li>• Export</li> </ul>

<b>Meters</b>	<p><i>Power:</i></p> <ul style="list-style-type: none"> <li>• <i>Frequency</i></li> <li>• <i>Voltage</i></li> <li>• <i>Current</i></li> <li>• <i>Power</i></li> </ul> <p><i>Battery:</i></p> <ul style="list-style-type: none"> <li>• <i>Overview</i></li> <li>• <i>Details</i></li> <li>• <i>Test</i></li> </ul> <p><i>Measure logs:</i></p> <ul style="list-style-type: none"> <li>• <i>Configuration</i></li> <li>• <i>Measure logs</i></li> </ul>
<b>Controls</b>	<p><i>Control of:</i></p> <ul style="list-style-type: none"> <li>• <i>Entire UPS</i></li> <li>• <i>Outlets</i></li> </ul>
<b>Protection</b>	<ul style="list-style-type: none"> <li>• <i>Scheduled shutdown</i></li> <li>• <i>Agent list</i></li> <li>• <i>Agent settings</i></li> <li>• <i>Power outage policy</i></li> </ul>
<b>Sensors*</b>	<ul style="list-style-type: none"> <li>• <i>Status</i></li> <li>• <i>Alarm configuration</i></li> <li>• <i>Information</i></li> </ul>
<b>Card</b>	<ul style="list-style-type: none"> <li>• <i>System information</i></li> <li>• <i>System logs</i></li> <li>• <i>Administration</i></li>   <li>• <i>Commissioning (Sensors)</i></li> </ul>



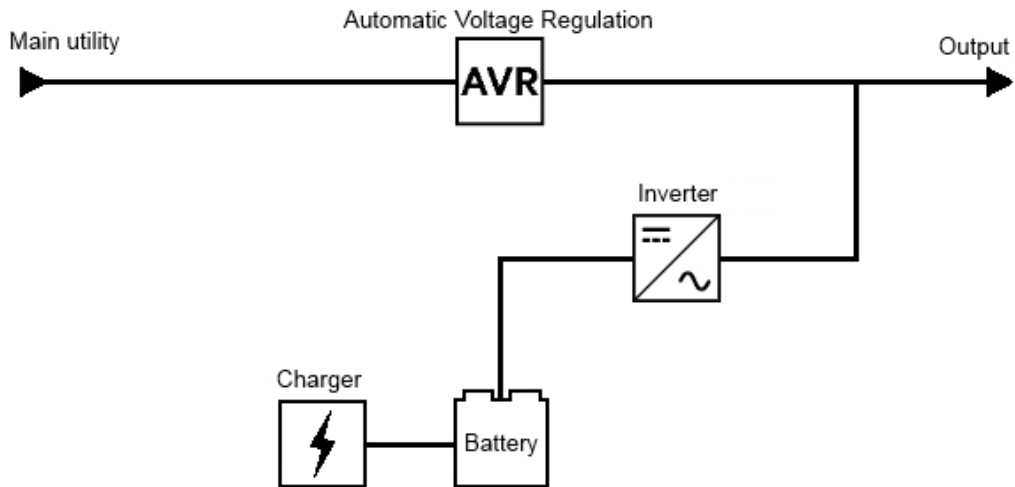

\* Displayed when sensors are commissioned in Card menu.

## 2.2.2 Energy flow diagram



### 2.2.2.1 Line interactive

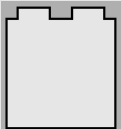

#### 2.2.2.1.1 Diagram elements description

Description and symbols	Description	Possible states			
		Green	Yellow	Red	Black / White / Greyed
<b>Input</b> 	Main utility input.	Powered	Out of nominal range		Not present Unknown
<b>AVR device.</b> 	The equipment is protected and powered through an AVR device.	Normal mode Buck mode Boost mode	In overload		Not powered Unknown
<b>Output</b> 	Output of the UPS.	Protected	In overload Not protected	In short circuit	Not powered Unknown
<b>Charger</b> 	Internal battery <b>charger</b> .	Charging Floating		In fault	Resting Not powered Unknown
<b>Battery status</b> 	Battery status information.	Powering the load	End of life	In fault Not present	Not used to power the load Unknown

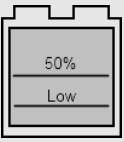

<b>Battery level</b> 	Battery level for the backup power.	> 50% and > low battery threshold (Settable on the UPS)	< 50% and > low battery threshold (Settable on the UPS)	< Below low battery threshold (Settable on the UPS)	
<b>Inverter</b> 	<b>Inverter:</b> convert DC power to AC power.	Powered	In overload	In short circuit In fault	Not powered Unknown
<b>Wiring</b> 	Electrical connection between blocks.	Energy flow	In overload Out of nominal range		No energy Unknown

### 2.2.2.1.2 Line interactive diagram examples

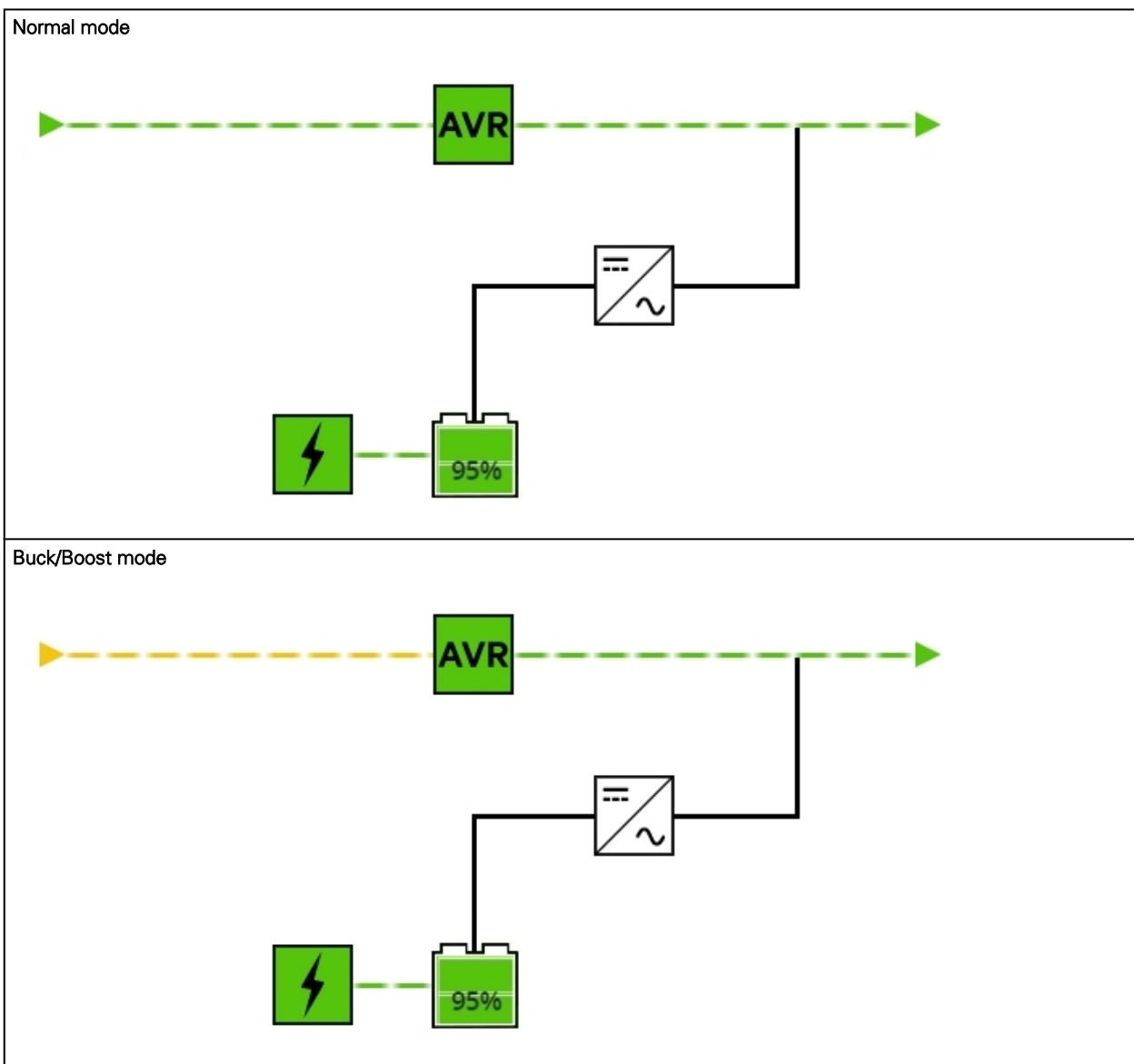

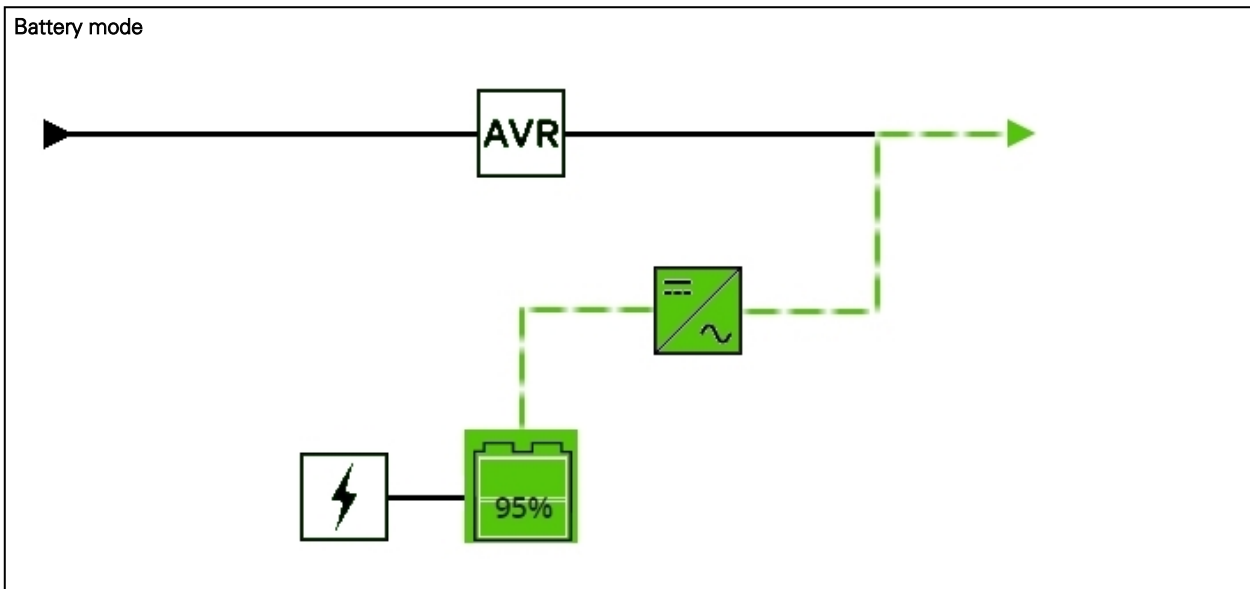



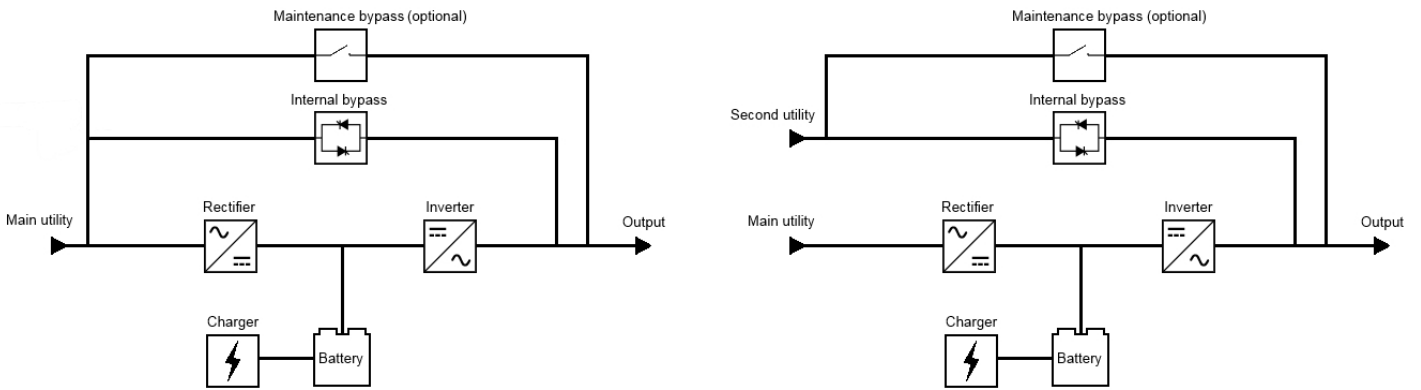





### 2.2.2.2 Online

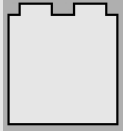
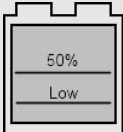
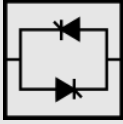

#### 2.2.2.2.1 Diagram elements description

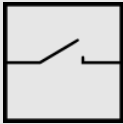
Description and symbols	Description	Possible states			
		Green	Yellow	Red	Black or white
<b>Input</b> 	Main utility or second utility.	Powered	Out of nominal range		Not present Unknown
<b>Rectifier</b> 	Rectifier: convert AC power to DC power.	Powered HE mode (ready) / ESS mode (ready)	In overload	In short circuit In fault	Not powered Unknown
<b>Inverter</b> 	Inverter: convert DC power to AC power.	Powered HE mode (ready) / ESS mode (ready)	In overload	In short circuit In fault	Not powered Unknown

<b>Output</b> 	Output of the UPS.	Protected	In overload Not protected	In short circuit	Not powered Unknown
<b>Charger</b> 	Internal battery charger.	Charging Floating		In fault	Resting Not powered Unknown
<b>Battery status</b> 	Battery status information.	Powering the load	End of life	In fault Not present	Not used to power the load Unknown
<b>Battery level</b> 	Battery level for the backup power.	> 50% and > low battery threshold (Settable on the UPS)	< 50% and > low battery threshold (Settable on the UPS)	< Below low battery threshold (Settable on the UPS)	
<b>Automatic bypass</b> 	Automatic bypass.	Powered (standby, auto bypass, forced bypass, HE mode, ESS mode)	In overload	In fault	Not powered Unknown
<b>Maintenance bypass (optional)</b> 	Maintenance bypass closed.	Powered (maintenance bypass)			Not powered Unknown
	Maintenance bypass opened.				
<b>Wiring</b> 	Electrical connection between blocks.	Energy flow	In overload Out of nominal range		No energy Unknown

### 2.2.2.2.2 Online diagram examples

	Single input source	Dual input sources
--	---------------------	--------------------

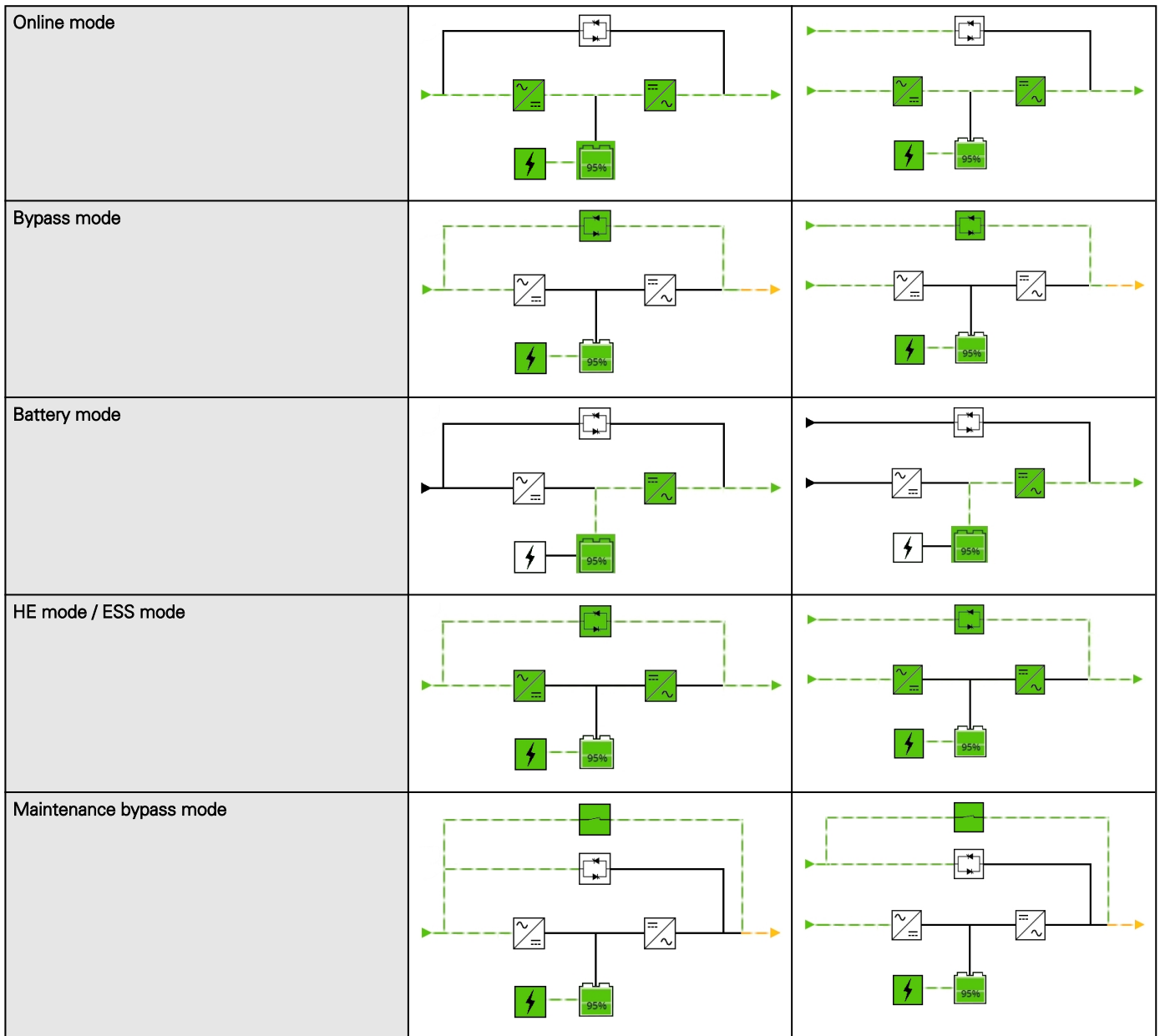

## 2.2.3 Top bar

Card name – Displays the card name

UPS name – Displays by default the UPS model or the system name if filled in the section Card>>>System information>>>System name

Current user – Displays current user name

Logout – Logs the current user out by destroying the current user session

Status – Provides device (example UPS) status information

Output power – Provides output power status information

Battery status – Provides battery status information

Alarms button – Open alarm page

Settings button – Open settings page

## 2.2.4 Details

This view provides a summary of device identification information and nominal values:

- Name
- Model
- P/N
- S/N
- Location
- Firmware version
- Input Voltage
- Input Frequency
- Output Voltage
- Output Frequency

The **COPY TO CLIPBOARD** button will copy the information to your clipboard so that it can be past.

For example, you can copy and paste information into an email.

## 2.2.5 Show measures

Provides input and output measures on the synoptic.

### 2.2.5.1 Example #1

Single input source with 1 phase in and 1 phase out:

Input measures	Output measures
Voltage (V)	Voltage (V)
Current (A)	Current (A)
Frequency (Hz)	Frequency (Hz)

### 2.2.5.2 Example #2

Dual input sources with 3 phases in and 3 phases out

Input measures (main and secondary)			Output measures		
Phase #1	Phase #2	Phase #3	Phase #1	Phase #2	Phase #3
Voltage (V)	Voltage (V)	Voltage (V)	Voltage (V)	Voltage (V)	Voltage (V)
Current (A)	Current (A)	Current (A)	Current (A)	Current (A)	Current (A)
					Load (W)
					Load (%)
Frequency (Hz)			Frequency (Hz)		

## 2.2.6 Outlet status

Provides the status of the UPS outlets (ON/OFF) by load segmentation:

- Status (ON/OFF— Protected/Not protected/Not powered)
- Load level (W) – availability depending on the UPS model
- Shutdown countdown
- Startup countdown



Note: Load segmentations allow non-priority equipment to automatically power down during an extended power outage to keep battery runtime on essential equipment. This feature is also used to remote reboot and sequential start servers to restrict inrush currents.

## 2.2.7 Active Alarms

Only active alarms are displayed, the Alarms icon will also display the number of active alarms.

Alarms are sorted by date, alert level, time, and description.

Note: To see the alarm history, press the **Alarms** button.

## 2.3 Alarms

The screenshot shows the Alarms interface. At the top left, there is a 'Status: All' dropdown menu. In the top right corner, it indicates '4 Active' alarms. The main list of alarms is sorted by date, with the most recent date being 10/04/2018. The first alarm in this group is 'Eaton 5P 850 - Load not powered', which is highlighted in bold and has an 'Active' label. Other alarms include 'Primary - Group is OFF', 'Group 2 - Group is OFF', and 'Group 1 - Group is OFF'. Below this, there is a section for 10/03/2018 with several 'Group is ON' and 'Eaton 5P 850' related alarms. At the bottom of the list, there are navigation buttons: 'First', 'Previous', 'Next', and 'Items per page: 10'. There are also 'Clear' and 'Export' buttons at the bottom right. A detailed view for the 'Load not powered' alarm is shown on the right, including a warning icon, the device name 'Eaton 5P 850', and 'Active' status. Below this, it shows 'Code 801', 'State Opening', 'Severity Warning', and 'Appeared on Disappeared on 10/04/2018 10:35:52 CEST'.

### 2.3.1 Alarm sorting

Alarms can be sorted by selecting:

- All
- Active only

### 2.3.2 Alarm details

All alarms are displayed and sorted by date, with alert level, time, description, and status.

	Info/Warning/Critical logo	Alarm description text
<b>Active</b>	In color	In bold with "Active" label
<b>Opened</b>	In color	
<b>Closed</b>	Greyed	

### 2.3.3 Alarm paging

The number of alarms per page can be changed (10-15-25-50-100).

When the number of alarms is above the number of alarms per page, the buttons **First**, **Previous** and **Next** appears to allow navigation in the Alarm list.

## 2.3.4 Alarm export

Press the **Export** button to download the file.

## 2.3.5 Clear alarm logs

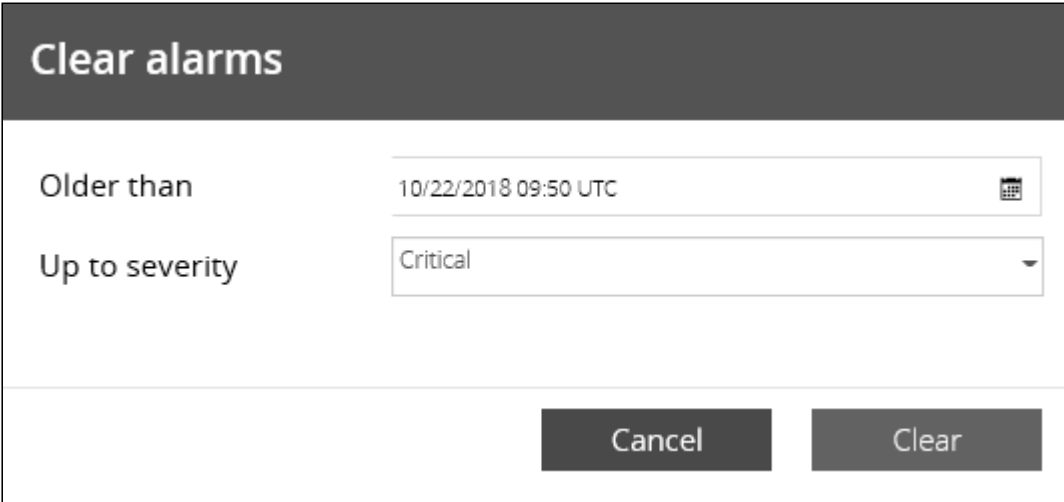

**Clear alarms**

Older than

Up to severity

**Cancel** **Clear**

Press the **Clear** button to clear alarms that are older than a specified date and up to a defined severity.

## 2.3.6 Alarm list with codes



For details on alarm codes, see the *Information>>>Alarm log codes* section.

## 2.4 Settings

### 2.4.1 General

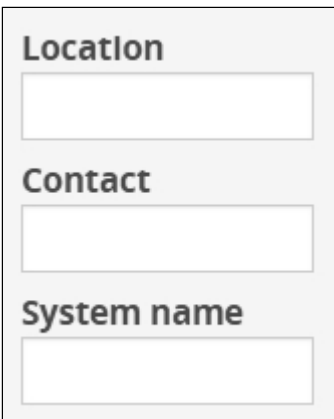

**Location**

**Contact**

**System name**

#### 2.4.1.1 Location

Text field that is used to provide the card location information.

Card system information is updated to show the defined location.

### 2.4.1.2 Contact

Text field that is used to provide the contact name information.

Card system information is updated to show the contact name.

### 2.4.1.3 System name

Text field that is used to provide the system name information.

Card system information is updated to show the system name.

### 2.4.1.4 Default settings parameters and limitations



For details on default parameters and limitations, see the *Information>>>Default settings parameters* section.

## 2.4.2 Date & Time

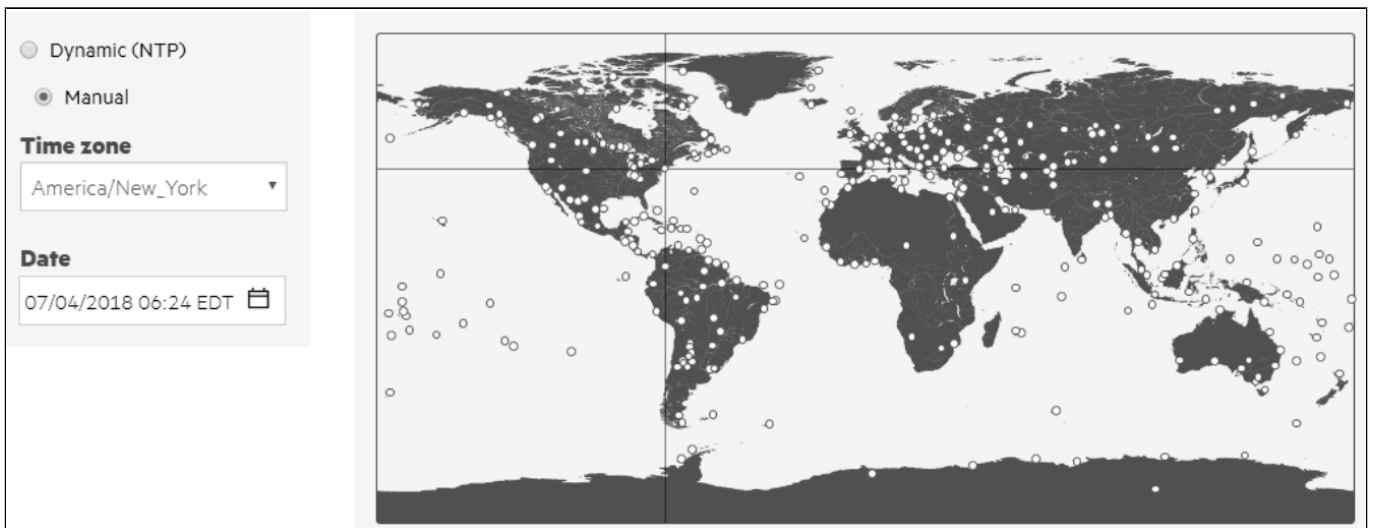

The current date and time appears in the footer at the bottom of the screen. You can set the time either manually or automatically.

#### 2.4.2.1 Manual: Manually entering the date and time

1. Select the time zone for your geographic area from the time zone pull-down menu or with the map.
2. Select the date and time.
3. Save the changes.

#### 2.4.2.2 Dynamic (NTP): Synchronizing the date and time with an NTP server

1. Enter the IP address or host name of the NTP server in the NTP server field.
2. Select the time zone for your geographic area from the time zone pull-down menu or with the map.
3. Save the changes.

**Note:** DST is managed based on the time zone.



### 2.4.2.3 Default settings parameters and limitations



For details on default parameters and limitations, see the *Information>>>Default settings parameters* section.

## 2.4.3 Users

### 2.4.3.1 Password strength rules

#### Password strength

Minimum length	<input style="width: 90%;" type="text" value="8"/>
<input checked="" type="checkbox"/> Minimum upper case	<input style="width: 90%;" type="text" value="1"/>
<input checked="" type="checkbox"/> Minimum lower case	<input style="width: 90%;" type="text" value="1"/>
<input checked="" type="checkbox"/> Minimum digit	<input style="width: 90%;" type="text" value="1"/>
<input checked="" type="checkbox"/> Special character <span style="font-size: small;">?</span>	<input style="width: 90%;" type="text" value="1"/>

To set the password strength rules, apply the following restrictions:

- Minimum length
- Minimum upper case
- Minimum lower case
- Minimum digit
- Special character

Press **Save** after modifications.

### 2.4.3.2 Account expiration

#### Account expiration

<input type="checkbox"/> Password expires after	<input style="width: 90%;" type="text" value="90"/>	days
<input type="checkbox"/> Main administrator password never expires <span style="font-size: small;">?</span>		
<input type="checkbox"/> Block account when invalid password is entered after	<input style="width: 90%;" type="text" value="4"/>	tries
<input type="checkbox"/> Main administrator account never blocks <span style="font-size: small;">?</span>		

To set the account expiration rules, apply the following restrictions:

- Password expires after (in days).

The main administrator password never expires.



1. If this feature is disabled, the administrator account can be locked after the password expiration.
2. If Enabled, the administrator password never expires, make sure it is changed regularly.

- Block account when invalid password is entered after (in number of attempts).

The main administrator account will never block.



1. If this feature is disabled, the administrator account can be locked after the number of failed connections defined.
2. If Enabled, the security level of the administrator account is reduced because unlimited password entry attempts are allowed.

Press **Save** after modifications.

### 2.4.3.3 Session expiration

#### Session expiration

No activity timeout	<input style="width: 80%;" type="text" value="15"/>	minutes
Session lease time <span style="font-size: 0.8em;">?</span>	<input style="width: 80%;" type="text" value="120"/>	minutes

Modification on the session lease time will take effect at next session

To set the session expiration rules, apply the following restrictions:

- No activity timeout (in minutes).

If there is no activity, session expires after the specified amount of time.

- Session lease time (in minutes).

If there is activity, session still expires after the specified amount of time.

Press **Save** after modifications.

### 2.4.3.4 Local users table

### Local users

New
Delete

2 Users

	Username	Email	Profile	Status	
<input type="checkbox"/>	admin		Administrator	Active	
<input type="checkbox"/>	user1		Viewer	Active	

The table shows all the supported local user accounts and includes the following details:

- Username
- Email
- Profile

		Administrator	Operator	Viewer
Home		✓	✓	✓
Alarms	Alarm list	✓	✓	✓
	Export	✓	✓	✓
	Clear	✓	✓	✗
Settings	General	✓	✗	✗
	Date & Time	✓	✗	✗
	Users	✓	✗	✗
	Network	✓	✗	✗
	Protocols	✓	✗	✗
	SNMP	✓	✗	✗
	Certificates	✓	✗	✗
	Email	✓	✗	✗
	My preferences	✓	✓	✓
Meters	Power	✓	✓	✓
	Battery	✓	✓	✓
	Measure logs	✓	✓	✓
	Configuration	✓	✓	✗
Controls		✓	✓	✗
Protection		✓	✓	✗
Sensors	Status	✓	✓	✓
	Alarm configuration	✓	✓	✗

	Information	✓	✓	✓
Card	System information	✓	✓	✓
	Resources	✓	✓	✓
	System logs	✓	✗	✗
	Administration	✓	✗	✗
	Commissioning (Sensors)	✓	✓	✗
Legal information (footer)		✓	✓	✓
Contextual and Full documentation		✓	✓	✓
Command Line Interface	get release info	✓	✓	✓
	history	✓	✓	✓
	ldap-test	✓	✗	✗
	logout	✓	✓	✓
	maintenance	✓	✗	✗
	netconf (read-only)	✓	✓ (read-only)	✓ (read-only)
	ping and ping6	✓	✗	✗
	reboot	✓	✗	✗
	save_configuration   restore_configuration	✓	✗	✗
	sanitize	✓	✗	✗
	ssh-keygen	✓	✗	✗
	time	✓	✓ (read-only)	✓ (read-only)
	traceroute and traceroute6	✓	✗	✗
	whoami	✓	✓	✓
	email-test	✓	✗	✗
	systeminfo_statistics	✓	✓	✓
	certificates	✓	✗	✗

- **Status** – Status could take following values – Inactive/Locked/Password expired/Active

### 2.4.3.4.1 Actions

#### a Add

Press the **New** button to create up to ten new users.

#### b Remove

Select a user and press the **Delete** button to remove it.

#### c Edit

Press the pen logo to edit user information and access to the following settings:

- Active
- Profile
- Username
- Full name
- Email
- Phone
- Organization – Notify by email about account modification/Password
- Reset password
- Generate randomly
- Enter manually
- Force password to be changed on next login

### 2.4.3.5 LDAP

LDAP			
<b>Configure</b>		<b>Profile mapping</b>	<b>Users preferences</b>
			Status <b>Stopped</b>
Name	Address	Port	Security
		636	SSL + Server verified <a href="#">LDAP certificate</a>
			SSL + Server verified <a href="#">LDAP certificate</a>

The table shows all the supported servers and includes the following details:

- Name
- Address
- Port
- Security
- Status – Status could take following values – Unreachable/Active

## 2.4.3.5.1 Actions

### a Configure

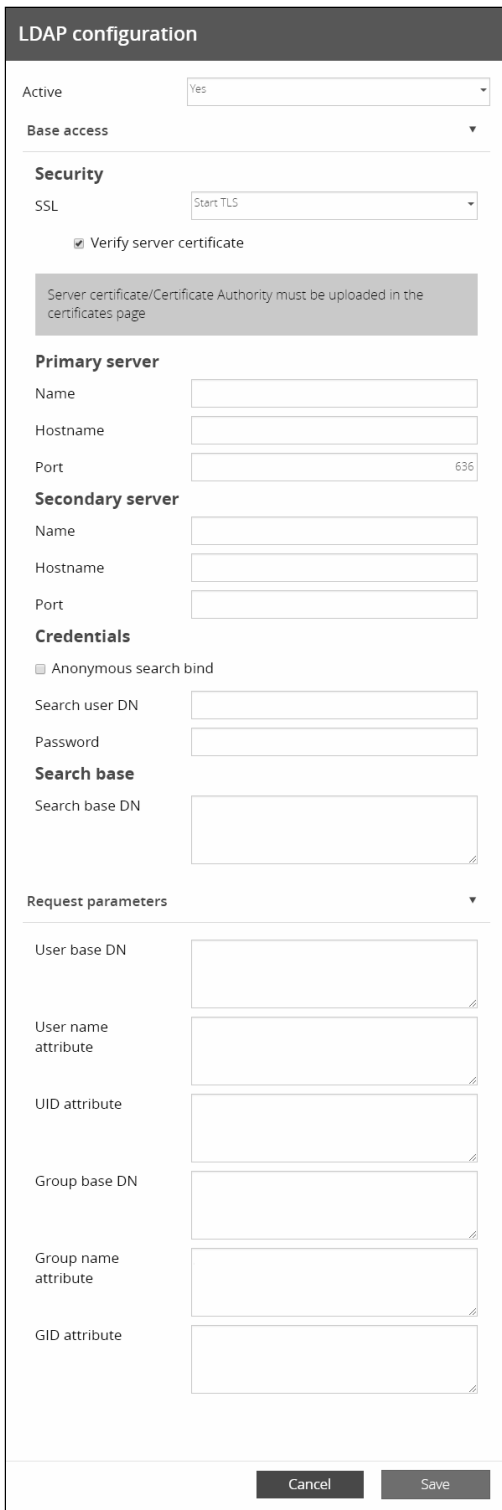

The image shows a web-based configuration form titled "LDAP configuration". The form is organized into several sections:

- Active:** A dropdown menu currently set to "Yes".
- Base access:** A dropdown menu.
- Security:** A dropdown menu currently set to "Start TLS". Below it is a checked checkbox labeled "Verify server certificate". A grey informational box states: "Server certificate/Certificate Authority must be uploaded in the certificates page".
- Primary server:** Three input fields for "Name", "Hostname", and "Port" (with a default value of "636").
- Secondary server:** Three input fields for "Name", "Hostname", and "Port".
- Credentials:** A checkbox for "Anonymous search bind" (unchecked). Below it are input fields for "Search user DN" and "Password".
- Search base:** An input field for "Search base DN".
- Request parameters:** A dropdown menu. Below it are seven input fields: "User base DN", "User name attribute", "UID attribute", "Group base DN", "Group name attribute", and "GID attribute".

At the bottom of the form are two buttons: "Cancel" and "Save".

1. Press **Configure** to access the following LDAP settings:

- Active
- Base access

- Security
    - SSL – None/Start TLS/SSL
    - Verify server certificate
  - Primary server – Name/Hostname/Port
  - Secondary server – Name/Hostname/Port
  - Credentials – Anonymous search bind/Search user DN/Password
  - Search base – Search base DN
- Request parameters
    - User base DN
    - User name attribute
    - UID attribute
    - Group base DN
    - Group name attribute
    - GID attribute

2. Click **Save**.

#### b Profile mapping

### LDAP profile mapping

Remote group	Local profile
	▼
	▼
	▼
	▼
	▼

Cancel
Save

1. Press **Profile mapping** to map remote groups to local profiles.
2. Click **Save**.

#### c Users preferences



All users preferences will apply to all remote users (LDAP, RADIUS).

## Remote users preferences

This settings will apply to all remote users (LDAP, RADIUS)

Language: English (US) ▼

Temperature: °C ▼

Date format: MM/DD/YYYY ▼

Time format: 24h ▼

Cancel Save

1. Press **Users preferences** to define preferences that will apply to all LDAP users

- Language
- Temperature
- Date format
- Time format

2. Click **Save**.

### 2.4.3.6 RADIUS



Radius is not a secured protocol, for a maximum security, it is recommended to use LDAP over TLS.

RADIUS

Configure Profile mapping User preferences

Name	Address	Port
adadssdad	13	1812
		1812

The table shows all the supported servers and includes the following details:

- Name
- Address



### 2.4.3.6.1 Actions

#### a Configure

## RADIUS configuration

Active	<input type="text" value="No"/>
Authentication protocol	PAP
Retry number	<input type="text" value="0"/>
<b>Primary server</b>	
Name	<input type="text"/>
Secret	<input type="text" value="...."/>
Address	<input type="text" value="13"/>
UDP port	<input type="text" value="1812"/>
Time out (sec)	<input type="text" value="3"/>
<b>Secondary server</b>	
Name	<input type="text"/>
Secret	<input type="text"/>
Address	<input type="text"/>
UDP port	<input type="text" value="1812"/>
Time out (sec)	<input type="text" value="3"/>

1. Press **Configure** to access the following RADIUS settings:

- Active
- Retry number
- Primary server – Name/Secret/Address//UDP port/Time out (s)
- Secondary server – Name/Secret/Address/UDP port/Time out (s)

2. Click **Save**.

b Profile mapping

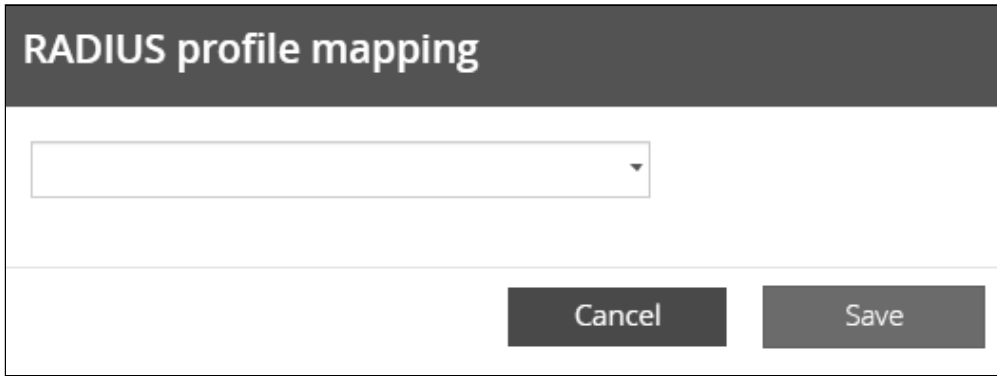

The screenshot shows a dialog box titled "RADIUS profile mapping". It features a single dropdown menu at the top. At the bottom of the dialog, there are two buttons: "Cancel" and "Save".

1. Press **Profile mapping** to map RADIUS profile to local profiles.
2. Click **Save**.

c Users preferences



All users preferences will apply to all remote users (LDAP, RADIUS).

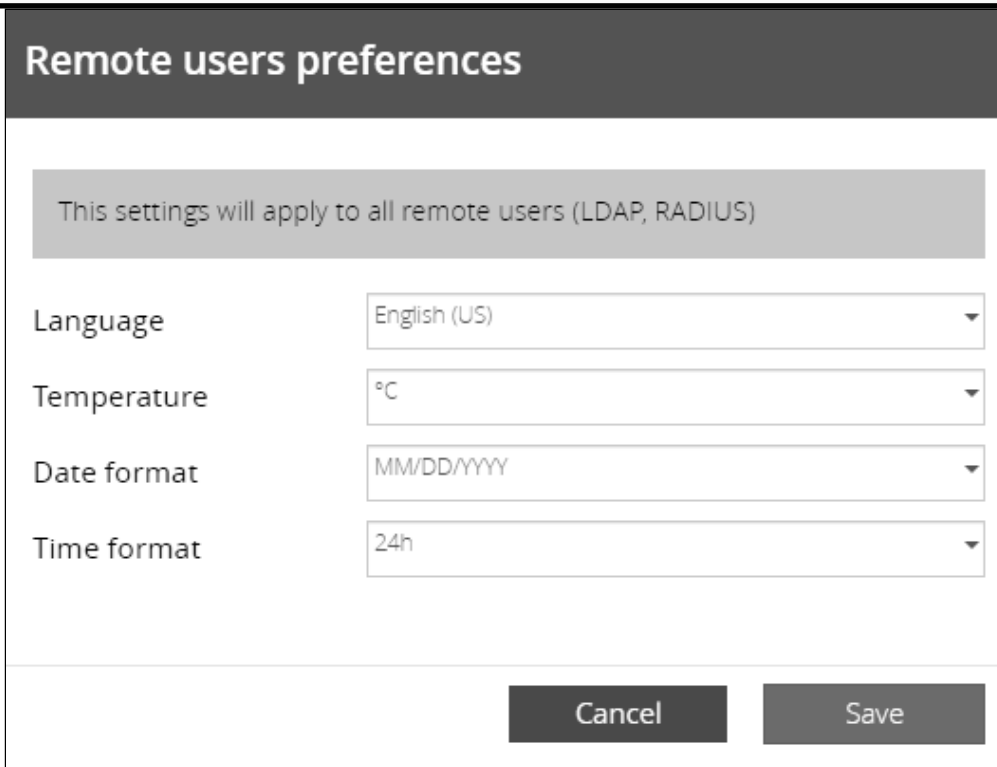

The screenshot shows a dialog box titled "Remote users preferences". At the top, there is a grey bar with the text "This settings will apply to all remote users (LDAP, RADIUS)". Below this, there are four rows of settings, each with a label and a dropdown menu:

- Language: English (US)
- Temperature: °C
- Date format: MM/DD/YYYY
- Time format: 24h

At the bottom of the dialog, there are two buttons: "Cancel" and "Save".

1. Press **Users preferences** to define preferences that will apply to all LDAP users
  - Language
  - Temperature
  - Date format
  - Time format
2. Click **Save**.

### 2.4.3.7 Default settings parameters and limitations



For details on default parameters and limitations, see the *Information>>>Default settings parameters* section.

## 2.4.4 Network

### 2.4.4.1 LAN

**LAN**

**Link status**  
1.0Gbps - Full duplex

**MAC address**  
60:64:09:F6:03:03

**Configuration**

1.0Gbps - Full duplex ▼

Modifications will take effect at next restart

A LAN is a computer network that interconnects computers within a limited area.

The available values for LAN configuration are listed below:

- Auto negotiation
- 10Mbps - Half duplex
- 10Mbps - Full duplex
- 100Mbps - Half duplex
- 100Mbps - Full duplex
- 1.0 Gbps - Full duplex

Any modifications are applied after the next Network Module reboot.

### 2.4.4.2 IPv4



Any modifications are applied after the Network Module reboots.

## IPv4

**Status** In service

**Mode** Manual

**Address** 00.000.00.000

**Netmask** 00.000.00.000

**Gateway** 00.000.00.0

More

Press the **More** button to configure the network settings, select either the Manual or Dynamic settings option:

### IPv4 details

Mode

Address

Netmask

Gateway

Cancel
Save

#### 2.4.4.2.1 Manual

Select Manual, and then enter the network settings if the network is not configured with a BootP or DHCP server.

- Enter the IP Address.  
The Network Module must have a unique IP address for use on a TCP/IP network.
- Enter the netmask.  
The netmask identifies the class of the sub-network the Network Module is connected to.
- Enter the gateway address.  
The gateway address allows connections to devices or hosts attached to different network segments.

### 2.4.4.2 Dynamic (DHCP)

Select dynamic DHCP to configure network parameters by a BootP or DHCP server.

If a response is not received from the server, the UPS Network Module boots with the last saved parameters from the most recent power up. After each power up, the UPS Network Module makes five attempts to recover the network parameters.

### 2.4.4.3 Domain

**Domain**

**Mode** Manual

**FQDN**  
genesi-demo01.mbx.lab.401.com

**Primary DNS**  
10.130.32.2

**Secondary DNS**  
100.130.32.6

**More**

The DNS is a hierarchical decentralized naming system for computers, services, or other resources connected to the Internet or a private network.

Press the **More** button to configure the network settings, select either the Static or Dynamic settings.

**Domain configuration**

Hostname

Mode

Domain name

Primary DNS

Secondary DNS

#### 2.4.4.3.1 Static

- Enter the Network Module Hostname.
- Enter the Network Module Domain name.

- Primary DNS server.  
Enter the IP address of the DNS server that provides the translation of the domain name to the IP address.
- Secondary DNS server.  
Enter the IP address of the secondary DNS server that provides the translation of the domain name to the IP address when the primary DNS server is not available.

### 2.4.4.3.2 Dynamic

- Enter the Network Module Hostname.

### 2.4.4.4 IPv6



IPv6 status and the first three addresses are displayed.

Press the **More** button to configure the network settings and get more information, press the **More** button for access to the following IPV6 details.

### IPv6 details

Current configuration ▾

---

Address

XXXXXXXXXXXXXXXXXXXXXXXXXXXXXXXX  
XXXXXXXXXXXXXXXXXXXXXXXXXXXXXXXX  
XXXXXXXXXXXXXXXXXXXXXXXXXXXXXXXX  
XXXXXXXXXXXXXXXXXXXXXXXXXXXXXXXX  
XXXXXXXXXXXXXXXXXXXXXXXXXXXXXXXX  
XXXXXXXXXXXXXXXXXXXXXXXXXXXXXXXX  
XXXXXXXXXXXXXXXXXXXXXXXXXXXXXXXX  
XXXXXXXXXXXXXXXXXXXXXXXXXXXXXXXX

Gateway

XXXXXXXXXXXXXXXXXXXXXXXXXXXXXXXX

Address settings ▾

---

Mode

Address

Prefix

Gateway

#### 2.4.4.4.1 Current configuration

- Address
- Gateway

#### 2.4.4.4.2 Address settings

Mode Manual

- Addresses
- Prefix
- Gateway

Mode router

### 2.4.4.4.3 DNS settings

- Get automatically (will hide the following settings)
- Primary DNS
- Secondary DNS

### 2.4.4.5 Default settings parameters and limitations



For details on default parameters and limitations, see the *Information>>>Default settings parameters* section.

## 2.4.5 Protocols

This tab contains settings for communication protocols used to get information from the device through the network, such as https for web browser.

### 2.4.5.1 HTTPS

### HTTPS

**Port**

Only https is available.

The default network port for https is 443. For additional security, the ports can be changed on this page.

Press **Save** after modifications.



Since only https is available, port 80 is not supported.

### 2.4.5.2 Syslog

### Syslog

Enable **Stopped**

Name	Address	Port	Protocol	Status	
Primary		514	UDP	<b>Inactive</b>	
		514	UDP	<b>Inactive</b>	

**Save**

#### 2.4.5.2.1 Settings

This screen allows an administrator to configure up to two syslog servers.



To configure the syslog server settings:

**a 1- Enable syslog.**

Press **Save** after modifications.

**b 2- Configure the syslog server:**

**Edit syslog server configuration**

Name	<input type="text" value="Primary"/>
Active	<input type="button" value="No"/>
Hostname	<input type="text"/>
Port	<input type="text" value="514"/>
Protocol	<input type="button" value="UDP"/>
Message transfer method	<input type="button" value="Non transparent framing"/>
<input type="checkbox"/> Using unicode byte order mask (BOM)	
<input type="button" value="Cancel"/> <input type="button" value="Save"/>	

1. Click the edit icon  to access settings.
2. Enter or change the server name.
3. Select **Yes** in the Active drop-down list to activate the server.
4. Enter the Hostname and Port.
5. Select the Protocol – UDP/TCP.
6. In TCP, select the message transfer method – Octet counting/Non-transparent framing.
7. Select the option Using Unicode BOM if needed.
8. Press **Save** after modifications.

### 2.4.5.3 Default settings parameters and limitations



For details on default parameters and limitations, see the *Information>>>Default settings parameters* section.

### 2.4.6 SNMP

This tab contains settings for SNMP protocols used for network management systems.



Changes to authentication settings need to be confirmed by entering a valid password for the active user account.

## 2.4.6.1 SNMP tables



The default port for SNMP is 161 and normally this should not be changed. Some organizations prefer to use non-standard ports due to cybersecurity, and this field allows that.

**SNMP**

Enable Supported MIBs

Port

**SNMP V1 (enabled)**

Community	Access	Status	
public	Read only	Active	✎
private	Read/Write	Active	✎

**SNMP V3 (enabled)**

Users	Access	Security level	Status	
readonly	Read only	Auth (SHA-1) - Priv (AES)	Active	✎
readwrite	Read/Write	Auth (SHA-1) - Priv (AES)	Active	✎

SNMP monitoring Battery status, power status, events, and traps are monitored using third-party SNMP managers.

To query SNMP data, you do not need to add SNMP Managers to the Notified Application page.

To set-up SNMP managers:

- Configure the IP address.
- Select SNMP V1 or V1 and V3.
- Compile the MIB you selected to be monitored by the SNMP manager.

For a list of supported MIBs, see the *Information>>>Specifications/Technical characteristics* section

Press the **Supported MIBs** button to download the MIBs.

### 2.4.6.1.1 Settings

This screen allows an administrator to configure SNMP settings for computers that use the MIB to request information from the UPS Network Module.

Default ports for SNMP are 161 (SNMP v1 and v3, set/get) and 162 (traps). These ports can be changed on the settings screen for additional security.

To configure the SNMP settings:

#### a 1- Enable the SNMP agent.

In addition to this also v1 and/or v3 must be enabled, along with appropriate communities and activated user accounts to allow SNMP communication.

Press **Save** after modifications.

## b 2- Configure the SNMP V1 settings:

1. Click the edit icon  on either Read-only or Read/Write account to access settings.
2. Enter the SNMP Community Read-Only string. The UPS Network Module and the clients must share the same community name to communicate.
3. Select **Yes** in the Active drop-down list to activate the account.
4. Access level is set to display information only.

## c 3- Configure the SNMP V3 settings:

1. Click the edit icon  on either Read Only or Read/Write account to access settings.

2. Edit the user name.
3. Select **Yes** in the Active drop-down list to activate the account.
4. Select access level.
  - Read only**—The user does not use authentication and privacy to access SNMP variables.
  - Read/Write**—The user must use authentication, but not privacy, to access SNMP variables.
5. Select the communication security mechanism.
  - Auth, Priv**—Communication with authentication and privacy.
  - Auth, No Priv**—Communication with authentication and without privacy.
  - No Auth, No Priv**—Communication without authentication and privacy.
6. If Auth is selected on the communication security mechanism, select the Authentication algorithms.



It is recommended to set SHA256/SHA384/SHA512 with the AES192/AES256 Privacy algorithms.

**SHA**— SHA1 is not recommended as it is not secured.

**SHA256**—fill in password and privacy keys. The password can be between 8 and 24 characters and use a combination of alphanumeric and the following special characters <>&@#%\_=:;,./?\$\*.

**SHA384**—fill in password and privacy keys. The password can be between 8 and 24 characters and use a combination of alphanumeric and the following special characters <>&@#%\_=:;,./?\$\*.

**SHA512**—fill in password and privacy keys. The password can be between 8 and 24 characters and use a combination of alphanumeric and the following special characters <>&@#%\_=:;,./?\$\*.

AES / AES192 / AES256

7. If Priv is selected on the communication security mechanism, select the Privacy algorithms.



It is recommended to set AES192/AES256 with the SHA256/SHA384/SHA512 Authentication algorithms.

**AES**— fill in password and privacy keys. The password can be between 8 and 24 characters and use a combination of alphanumeric and the following special characters <>&@#%\_=:;,./?\$\*.

**AES192**—fill in password and privacy keys. The password can be between 8 and 24 characters and use a combination of alphanumeric and the following special characters <>&@#%\_=:;,./?\$\*.

**AES256**—fill in password and privacy keys. The password can be between 8 and 24 characters and use a combination of alphanumeric and the following special characters <>&@#%\_=:;,./?\$\*.

8. Enter your own login password and click **Save**.

## 2.4.6.2 Trap receivers

Trap receivers						3 items
<input type="checkbox"/> <b>Application name</b>		<b>Host</b>	<b>Protocol</b>	<b>Port</b>	<b>Status</b>	
<input type="checkbox"/>	Trap V1 1	000.000.0.0	V1	162	<b>Active</b>	
<input type="checkbox"/>	Trap V1 2	000.000.0.0	V1	162	<b>Active</b>	
<input type="checkbox"/>	Trap V3 1	000.000.0.0	V3	162	<b>Active</b>	

The table shows all the trap receivers and includes the following details:

- **Application name**
- **Host**

- Protocol
- Port
- Status: Active/Inactive/Error(configuration error)

## 2.4.6.3 Actions

### 2.4.6.3.1 Add

1. Press the **New** button to create new trap receivers.

2. Set following settings:

- Active – Yes/No
- Application name
- Hostname or IP address
- Port
- Protocol – V1/V3
- Trap community (V1) / User (V3)

3. Press the **SAVE** button.

### 2.4.6.3.2 Remove

Select a trap receiver and press the **Delete** button to remove it.

### 2.4.6.3.3 Edit

Press the pen icon to edit trap receiver information and access to its settings.

### 2.4.6.3.4 Test all traps

Press the **Test all traps** button to send the trap test to all trap receivers.

Separate window provides the test status with following values:

- In progress

- Request successfully sent
- invalid type



For details on SNMP trap codes, see the *Information>>>SNMP traps* section.

## 2.4.6.4 Default settings parameters and limitations



For details on default parameters and limitations, see the *Information>>>Default settings parameters* section.

## 2.4.7 Certificates

### 2.4.7.1 Local certificates

Manage local certificates by :

- Generating CSR and import certificates signed by the CA.
- Generating new self-signed certificates.

#### 2.4.7.1.1 Local certificates table

Local certificates					
		Revoke	Export	Configure issuer	2 items
Used for	Issued by	Valid from	Expiration	Status	
<input type="checkbox"/> Protected applications (MQTT)	MQTT- <i>group domain</i> selfsigned	01/11/2018	01/11/2020	Valid	
<input type="checkbox"/> Web Server	Web server- <i>group domain</i> selfsigned	01/09/2018	01/09/2020	Valid	

The table shows the following information for each local certificate.

- Used for
- Issued by
- Valid from
- Expiration
- Status — valid, expires soon, or expired

#### 2.4.7.1.2 Actions

##### a Revoke

This action will take the selected certificate out of use.

Select the certificate to revoke, and then press the **Revoke** button.

A confirmation window appears, press **Continue** to proceed, this operation cannot be recovered.



Revoke will replace current certificate by a new self-signed certificate.

This may disconnect connected applications:

- Web browsers
- Shutdown application
- Monitoring application

The certificate that is taken out of use with the revoke action cannot be recovered.

## b Export

Exports the selected certificate on your OS browser window.

## c Configure issuer

Press the **Configure issuer** button.

A configuration window appears to edit issuer data.

**Issuer configuration**

Country	<input type="text" value="FR - France"/>
State or province	<input type="text"/>
City or locality	<input type="text"/>
Organization name	<input type="text"/>
Organization unit	<input type="text"/>
Contact email address	<input type="text"/>

Modification will take effect at next certificate generation

Cancel
Save

- Country
- State or Province
- City or Locality
- Organization name
- Organization unit
- Contact email address

Press **Save** button.



Issuer configuration will be applied only after the revoke of the certificate.

## d Edit

Allows access to the following:

- Certificate summary
- Actions
  - Generate a new self-signed certificate.

- Generate CSR.
- Import certificate (only available when CSR is generated).

- Details

### 2.4.7.1.3 Generate a new self-signed certificate

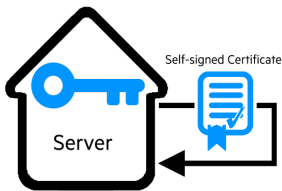

To replace a selected certificate with a new self-signed certificate.

This may disconnect applications such as a Web browser, shutdown application, or monitoring application.

This operation cannot be recovered.

### 2.4.7.1.4 Create new certificates:



#### a CSR

Press **Generate Signing Request** button in the in the certificate edition.

The CSR is automatically downloaded.

CSR must be signed with the CA, which is managed outside the card.

#### b Import certificate

When the CSR is signed by the CA, it can be imported into the Network Module.

When the import is complete, the new local certificate information is displayed in the table.

## 2.4.7.2 Certificate authorities (CA)

Manages CAs.

### 2.4.7.2.1 CA table

Certificate authorities (CA)						
Import		Revoke		1 items		
<input type="checkbox"/>	Used for	Issued by	Issued to	Valid from	Expiration	Status
<input type="checkbox"/>	Email	Escom-Road CA	Escom-Road CA	08/21/2016	08/21/2016	Valid

The table displays certificate authorities with the following details:

- Used for
- Issued by
- Issued to



- Valid from
- Expiration
- Status — valid, expires soon, or expired

### 2.4.7.2.2 Actions

#### a Import

When importing the CA, you must select the associated service, and then upload process can begin through the OS browser window.

#### b Revoke

Select the certificate to revoke, and then press the **Revoke** button.

A confirmation window appears, press **Continue** to proceed, this operation cannot be recovered.

#### Export

Exports the selected certificate on your OS browser window.

#### c Edit

Gives access to a summary of the certificate.

### 2.4.7.3 Pairing with clients



For details on pairing instructions, follow the link [pairing instructions](#) in the tile or see the [Servicing the Network Management Module](#) >>> *Pairing agent to the Network Module* section.

#### Pairing with clients

Trust new client certificate for

Start

[Pairing instructions](#)

During the selected timeframe, new connections to the Network Module are automatically trusted and accepted.

After automatic acceptance, make sure that all listed clients belong to your infrastructure. If not, access may be revoked using the Delete button.

The use of this automatic acceptance should be restricted to a secured and trusted network.

For maximum security, we recommend following one of the two methods on the certificate settings page:

- Import agent's certificates manually.
- Generate trusted certificate for both agents and Network Module using your own PKI.

#### 2.4.7.3.1 Actions

##### a Start



Starts the pairing window during the selected timeframe or until it is stopped.

Time countdown is displayed.

**b Stop**

Stops the pairing window.

**2.4.7.4 Trusted remote certificates**

Trusted remote certificates						
<input type="checkbox"/> <b>Used for</b>		<b>Issued by</b>	<b>Issued to</b>	<b>Valid from</b>	<b>Expiration</b>	<b>Status</b>
<input type="checkbox"/> Protected applications (MQTT)				09/21/2018	09/18/2023	<b>Valid</b> 

The table shows the following information for each trusted remote certificate.

- Used for
- Issued by
- Issued to
- Valid from
- Expiration
  - In case a certificate expires, the connection with the client will be lost. If this happens, the user will have to recreate the connection and associated certificates.
- Status — valid, expires soon, or expired

**2.4.7.4.1 Actions****a Import**

When importing the client certificate, you must select the associated service, and then upload process can begin through the OS browser window.

**b Revoke**

Select the certificate to revoke, and then press the **Revoke** button.

A confirmation window appears, press **Continue** to proceed, this operation cannot be recovered.

**c Edit **

Gives access to a summary of the certificate.

**2.4.7.5 Default settings parameters and limitations**

For details on default parameters and limitations, see the *Information>>>Default settings parameters* section.

**2.4.8 Email****2.4.8.1 Email sending configuration**

For examples on email sending configuration see the *Servicing the Network Management Module>>>Subscribing to a set of alarms for email notification* section.

**Email sending configuration** 3 items

**New** **Delete** **Send test email**

<input type="checkbox"/>	▲ Configuration name	Email address	Configuration	Status	
<input type="checkbox"/>	Configuration #1	Myname@email.com		<b>Active</b>	
<input type="checkbox"/>	Configuration #2	Myname@email.com		<b>Active</b>	
<input type="checkbox"/>	Configuration #3	Myname@email.com		<b>Active</b>	

### 2.4.8.1.1 Email sending configuration table

The table shows all the email sending configuration and includes the following details:

- **Configuration name**
- **Email address**
- **Configuration**  
Configuration displays Email delegation/Events notification/Periodic report icons when active.
- **Status** – Active/Inactive/In delegation

### 2.4.8.1.2 Actions

#### a Add

Press the **New** button to create a new email sending configuration.

#### b Remove

Select an email sending configuration and press the **Delete** button to remove it.

#### c Edit

Press the pen icon to edit email sending configuration and access to the following settings:

- Active
- Configuration name
- Email address
- Notify on events – Severity level/Attach logs/Exceptions on events notification
- Periodic report – Active/Recurrence/Starting/Topic selection – Card/Devices

### Edit email sending configuration

Active

Configuration name

Email address

**🔔 Notify on events (Enabled)**

---

Active

#### On card events

Severity	Subscribe	Attach logs
Critical	<input type="checkbox"/>	<input type="checkbox"/>
Warning	<input type="checkbox"/>	<input type="checkbox"/>
Info	<input type="checkbox"/>	<input type="checkbox"/>

#### On device events

Severity	Subscribe	Attach logs
Critical	<input checked="" type="checkbox"/>	<input checked="" type="checkbox"/>
Warning	<input type="checkbox"/>	<input type="checkbox"/>
Info	<input type="checkbox"/>	<input type="checkbox"/>

#### Exceptions on events notification

**+** Always notify events with code [?](#)

**—** Never notify events with code [?](#)

[List of event codes](#)

---

**📅 Periodic report (Enabled)**

Active

Recurrence

Starting

Topic	Subscribe	Attach logs
Card	<input type="checkbox"/>	<input type="checkbox"/>
Device	<input type="checkbox"/>	<input type="checkbox"/>

Cancel
Save

# SMTP

**SMTP**

**Server IP/Hostname**

**Port**

**Default sender address**

SMTP server authentication

**Username**

**Password**

Secure SMTP connection    Verify certificate authority

SMTP is an internet standard for electronic email transmission. The following SMTP settings are configurable:

- Server IP/Hostname – Enter the host name or IP address of the SMTP server used to transfer email messages in the SMTP Server field.
- Port
- Sender address
- Secure SMTP connection
- Verify certificate authority
- SMTP server authentication

Select the SMTP server authentication checkbox to require a user name and a password for SMTP authentication.

Enter the Username and the Password.

- Save and test server configuration

## 2.4.8.2 Default settings parameters and limitations



For details on default parameters and limitations, see the [Information>>>Default settings parameters](#) section.

## 2.4.9 My preferences



This page is in read-only mode when connected through LDAP and it displays the preferences applied to all LDAP users as configured in the [Settings>>>Users>>>LDAP-Users preferences](#) section.

## 2.4.9.1 Profile

### Profile

**Account**

**Username** admin  
**Password** [Change password](#)  
**Profile** Administrator

---

**Details** 

**Full Name** Administrator  
**Email** [admin@email.com](mailto:admin@email.com)  
**Phone**  
**Organization**

Click on **Change password** to change the password.



In some cases, it is not possible to change the password if it has already been changed within a day period.  
Refer to the troubleshooting section.

If you have the administrator's rights, you can press the **pen logo** to edit user profile and update the following information:

- Full name
- Email
- Phone
- Organization

## 2.4.9.2 Temperature

### Temperature

**25°C**  
Celsius

**77°F**  
Fahrenheit

- °C (Celsius)
- °F (Fahrenheit)

### 2.4.9.3 Date format



- YYYY-MM-DD
- DD-MM-YYYY
- DD.MM.YYYY
- DD/MM/YYYY
- MM/DD/YYYY
- DD MM YYYY

### 2.4.9.4 Time format

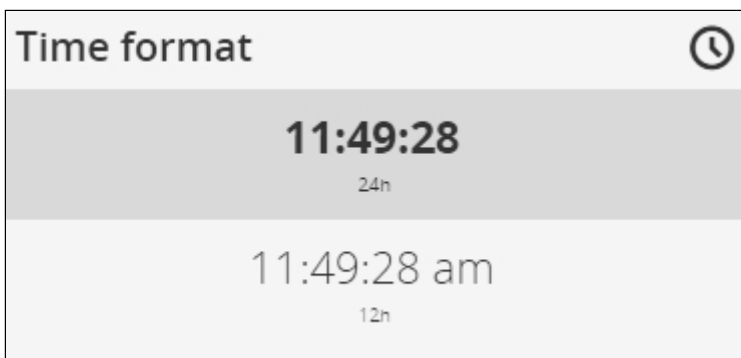

- hh:mm:ss (24h)
- hh:mm:ss (12h)

### 2.4.9.5 Language

- German
- English
- Spanish
- French
- Italian
- Japanese
- Simplified Chinese
- Traditional Chinese

### 2.4.9.6 Default settings parameters and limitations



For details on default parameters and limitations, see the *Information>>>Default settings parameters* section.

## 2.5 Meters

### 2.5.1 Power

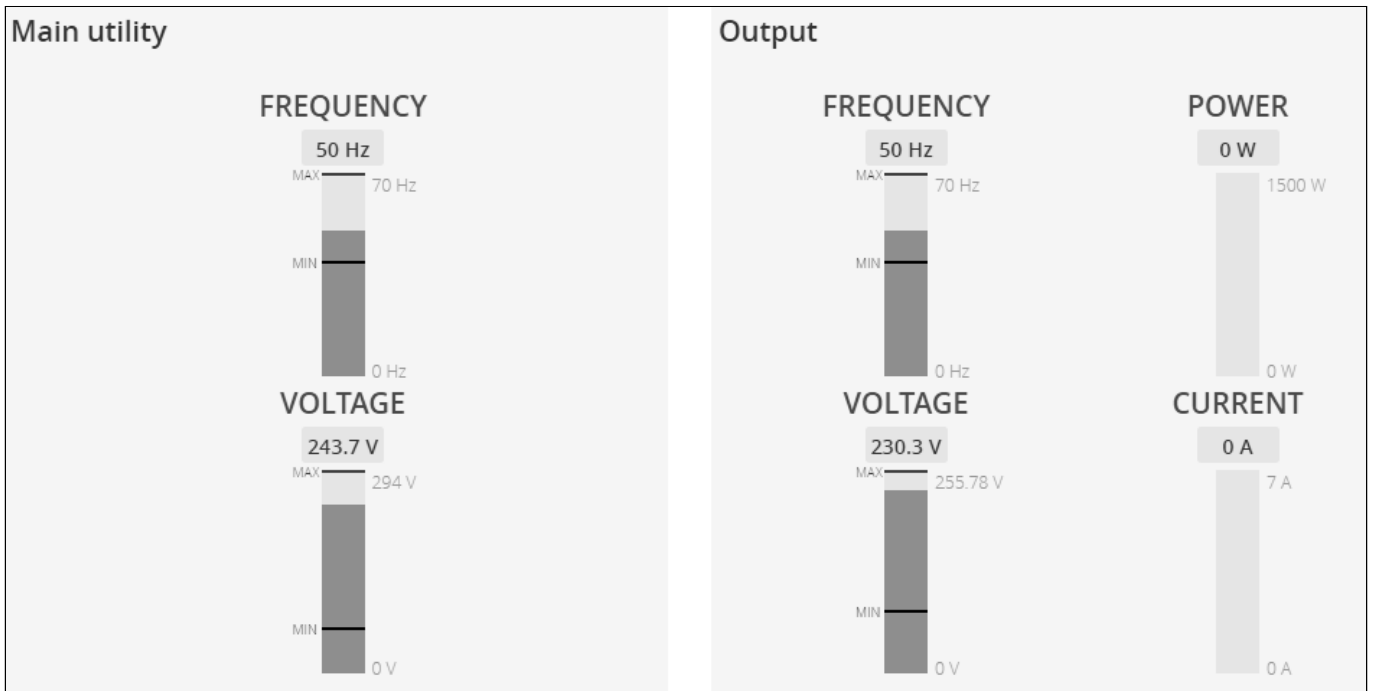

Displays the product input and output measures.



The numbers on the right side of a gauge show the scale. They do not indicate allowed or observed minimum or maximum levels.

#### 2.5.1.1 Input

- Frequency (Hz)
- Voltage (V)



## 2.5.1.2 Output

- Frequency (Hz)
- Voltage (V)
- Power (W)
- Current (A)

## 2.5.2 Battery

Battery section is an overview of the battery information and allow to launch a battery test.



The information displayed depends on the device.

### 2.5.2.1 Overview

- Type
- Nominal capacity
- Nominal voltage
- Capacity remaining
- Runtime
- State
- Recommended replacement date
- State of health

### 2.5.2.2 Details

- Voltage
- Current
- Temperature
- Min cell voltage
- Max cell voltage
- Number of cycles
- Min temperature
- Max temperature
- BMS state

### 2.5.2.3 Test

Status	Commands	Pending action
Pass	Test	Done

#### 2.5.2.3.1 Status

Battery test status reflects the last completed battery test result, as well as its critical status (color) and completion time.

- Pass
- Warning
- Fail
- Unknown

### 2.5.2.3.2 Commands

*Start* button is disabled if a battery test is already in progress or scheduled.

The *Abort* button is enabled only when a test is in progress or scheduled.

### 2.5.2.3.3 Pending action

The pending action reflects the battery test status.

- None
- Scheduled
- In progress
- Aborted
- Done

## 2.5.3 Measure logs

### 2.5.3.1 Configuration

#### Configuration

Log UPS measures every  seconds

[Save](#)

This log configuration allows to define the log acquisition frequency of the UPS measures only.



The sensors measures logs acquisition is not settable and done every minutes.

### 2.5.3.2 Measure logs

#### Measure logs

Click on the download button to retrieve the measure logs file

[Download UPS measures](#) | [Download Sensors measures](#)

Press the **Download UPS measures** button to download the UPS log file.

If available, possible measures are listed below:

- Input Voltage (V)
- Input Frequency (Hz)
- Bypass Voltage (V)
- Bypass Frequency (Hz)
- Output Voltage (V)
- Output Frequency (Hz)
- Output Current (A)
- Output Apparent Power (VA)
- Output Active Power (W)
- Output Power Factor

- Output Percent Load (%)
- Battery Voltage (V)
- Battery Capacity (%)
- Battery Remaining Time (s)

Press the **Download Sensors measures** button to download the sensors log file.

If available, possible measures are listed below:

- Temperature of <sensor\_1> (in K, 1 decimal digit)
- Humidity of <sensor\_1> (in %, 1 decimal digit)
- Temperature of <sensor\_2>> (in K, 1 decimal digit)
- Humidity of <sensor\_2> (in %, 1 decimal digit)
- Temperature of <sensor\_3> (in K, 1 decimal digit)
- Humidity of <sensor\_3> (in %RH, 1 decimal digit)

	$^{\circ}\text{C} = \text{K} - 273.15$ $^{\circ}\text{F} = \text{K} \times 9/5 - 459.67$
---	---

### 2.5.3.3 Default settings parameters and limitations

	For details on default parameters and limitations, see the <i>Information&gt;&gt;&gt;Default settings parameters</i> section.
---	---

## 2.6 Controls

### 2.6.1 UPS

Status	Commands			Pending action
Entire UPS	<b>ON Protected</b>	Switch ON	Safe OFF	Safe reboot

#### 2.6.1.1 Entire UPS

Controls are displayed for the entire UPS, and not for specific outlet options.

The table in this section displays UPS status, the associated commands (on/off), and the pending action.

##### 2.6.1.1.1 Status

Reflects the current mode of the UPS. The following is a list of potential table values that are displayed based on the UPS topology.

- On — Protected/Not protected
- Off — Not powered/Not protected

##### 2.6.1.1.2

A set of commands are available and activated when one of the following buttons is pressed. A confirmation window appears.

**a**

This will shut off the load. Protected applications will be safely powered down.

This control is available only if the status is not OFF and if there are no active commands running.

Comm

Safe OF

**b Safe reboot**

This will shut off and then switch ON the load. Protected applications will be safely powered down.

This control is available only if the status is not OFF and if there are no active commands running.

**c Switch ON**

This will switch ON the load or turn ON the online UPS.

This control is available when the status is OFF, if there are no active commands running and if the Online UPS is on bypass.

**2.6.1.1.3 Pending action**

Displays the delay before shutdown and delays before startup.

**2.6.2 Outlets**

	Status	Commands		Pending action
Group 1	ON Protected	Switch ON	Safe OFF	Safe reboot
Group 2	ON Protected	Switch ON	Safe OFF	Safe reboot

**2.6.2.1 Group 1/ Group 2**

Load segmentations allow, battery runtime to remain on essential equipment and automatically power down non-priority equipment during an extended power outage.

This feature is also used for remote reboot and the sequential start of servers to restrict inrush currents.

**2.6.2.1.1 Status**

It reflects the current outlet status:

- On — Protected/Not protected
- Off — Not powered

**2.6.2.1.2**

A set of commands are available and activated when one of the following buttons is pressed. A confirmation window appears.

**a**

This will shut off the load connected to the associated load segment. Protected applications are safely powered down.

This control is available only if the status is not OFF and if there are no active commands running.

**b Safe reboot**

This will power down and then switch ON the load connected to the associated load segment. Protected applications are safely powered down.

This control is available only if the status is not OFF and if there are no active commands running.

**c Switch ON**

This will switch ON the load connected to the associated load segment.

This control is available when status is OFF and if there are no active commands running.

Comm

Safe OF

### 2.6.2.1.3 Pending action

Displays the delay before shutdown and delay before startup.

## 2.7 Protection

### 2.7.1 Scheduled shutdowns

Use Scheduled shutdowns to turn off either the UPS or individual load segments at a specific day and time.

This feature is used for saving energy by turning off equipment outside of office hours or to enhance cybersecurity by powering down network equipment.

If server shutdown scenarios are defined for any of the connected servers or appliances, they will be triggered before the corresponding outlets are turned off as configured in shutdown settings.

#### 2.7.1.1 Scheduled shutdowns table

Scheduled shutdown					
New		Delete		3 Active rules	
<input type="checkbox"/>	Recurrence	Load segment	Shutdown time	Restart time	Status
<input type="checkbox"/>	Once	Primary	08/22/2018 08:44:00 (EST)	08/24/2018 08:44:00 (EST)	Active 
<input type="checkbox"/>	Every day	Group 1	08/22/2018 08:44:00 (EST)	10/02/2018 08:44:00 (EST)	Active 
<input type="checkbox"/>	Every week	Group 2	11/27/2018 08:45:00 (EST)	11/28/2018 08:45:00 (EST)	Active 

The table displays the scheduled shutdowns and includes the following details:

- **Active** – Yes/No
- **Recurrence** – Once/Every day/Every week
- **Load segment** – Primary/Group 1/Group 2
- **Shutdown** – Date/Time
- **Restart** – Date/Time

#### 2.7.1.2 Actions

##### 2.7.1.2.1 New

Press the **New** button to create a scheduled shutdown.

##### 2.7.1.2.2 Remove

Select a schedule shutdown and press the **Remove** button to delete the scheduled shutdown.

##### 2.7.1.2.3 Edit

Press the pen icon to edit schedule shutdown and to access the settings.

## 2.7.2 Agent list

### 2.7.2.1 Pairing with shutdown agents



For details on pairing instructions, follow the link [pairing instructions](#) in the tile or see the [Servicing the Network Management Module](#) >>> [Pairing agent to the Network Module](#) section.

#### Pairing with shutdown agents

Accepts new agents for

Start

[Pairing instructions](#)

Authentication and encryption of connections between the UPS network module and shutdown agents is based on matching certificates. Automated pairing of shutdown agents and UPS network modules is recommended in case the installation is done manually in a secure and trusted network, and when certificates cannot be created in other ways.

During the selected timeframe, new agent connections to the Network Module are automatically trusted and accepted.

After automatic acceptance, make sure that all listed agents belong to your infrastructure. If not, access may be revoked using the **Delete** button.

For maximum security, Eaton recommend following one of the two methods on the [certificate settings](#) page:

- import client certificates manually.
- generate trusted certificate for both clients and Network Module using your own PKI.

#### 2.7.2.1.1 Actions

##### a Start

Starts the pairing window for the selected timeframe or until it is stopped.

Time countdown is displayed.

##### b Stop

Stops the pairing window.

### 2.7.2.2 Agent list table

Agents list							
Delete							
Name	Address	Version	Power source (Policy)	Delay (s)	OS shutdown duration (s)	Status	Communication
IPP / 192.168.1.100	192.168.1.100	1.0.0	Primary (immediate graceful shutdown policy)	15	10	In service Protected	Connected

The table displays the IPP agent list that is connected to the Network Module and includes the following details:

- Name
- Address
- Version of the Agent
- Power source (Policy)
- Delay (in seconds)
- OS shutdown duration (in seconds)

- Status
  - In service | Protected
  - In service | Not protected
  - Stopping | Protected
  - Stopped | Protected
- Communication
  - Connected | yyyy/mm/dd hh:mm:ss
  - Lost | yyyy/mm/dd hh:mm:ss

## 2.7.2.3 Actions

### 2.7.2.3.1 Delete



When the agent is connected, the Delete function will not work correctly because the agent will keep on trying to re-connect.  
 So connect to the software, remove the Network module from the Software nodes list (in the nodes list, right click on the Network module and click **remove nodes**).

When communication with the agent is lost, agent can be deleted by using the **Delete** button.

Select an agent and press the **Delete** button to delete the agent.

## 2.7.3 Agent settings

### 2.7.3.1 Agent shutdown sequence timing

**Agent shutdown sequence timing**

**Primary**

Name	Delay (s)	OS shutdown duration (s)
Local	<input type="text"/>	120

**Group 1**

Name	Delay (s)	OS shutdown duration (s)
Local	<input type="text"/>	120

**Group 2**

Name	Delay (s)	OS shutdown duration (s)
Local	<input type="text"/>	120

All agents that are connected to the Network Module are displayed in tables by power sources.

- Primary
- Group 1
- Group 2

The 'local agent' setting is used for setting for example a minimum shutdown duration, or a power down delay for a load segment that has no registered shutdown agents. One use case would be a load segment that powers network equipment that needs to stay on while servers and storage perform their orderly shutdown.

The tables include the following details:

- Name
- Delay (in seconds)
- OS shutdown duration (in seconds)

## 2.7.3.2 Actions

### 2.7.3.2.1 Set Delay

Select and directly change the setting in the table and then **Save**.

### 2.7.3.2.2 Set OS shutdown duration

Select and directly change the setting in the table and then **Save**.

### 2.7.3.3 Examples

Examples below show the impact of agent settings on the shutdown sequence for an ordered shutdown or an immediate shutdown.

Agent settings examples	Sequential shutdown	Immediate shutdown												
<table border="1"> <thead> <tr> <th>Name</th> <th>delay (s)</th> <th>OS shutdown duration (s)</th> </tr> </thead> <tbody> <tr> <td>Local</td> <td></td> <td>120</td> </tr> <tr> <td>Agent 1</td> <td>120</td> <td>90</td> </tr> <tr> <td>Agent 2</td> <td>90</td> <td>60</td> </tr> </tbody> </table>	Name	delay (s)	OS shutdown duration (s)	Local		120	Agent 1	120	90	Agent 2	90	60		
Name	delay (s)	OS shutdown duration (s)												
Local		120												
Agent 1	120	90												
Agent 2	90	60												
<table border="1"> <thead> <tr> <th>Name</th> <th>delay (s)</th> <th>OS shutdown duration (s)</th> </tr> </thead> <tbody> <tr> <td>Local</td> <td></td> <td>0</td> </tr> <tr> <td>Agent 1</td> <td>60</td> <td>90</td> </tr> <tr> <td>Agent 2</td> <td>0</td> <td>180</td> </tr> </tbody> </table>	Name	delay (s)	OS shutdown duration (s)	Local		0	Agent 1	60	90	Agent 2	0	180		
Name	delay (s)	OS shutdown duration (s)												
Local		0												
Agent 1	60	90												
Agent 2	0	180												

**Note:** The trigger in the diagram is the moment when the shutdown sequence starts, and it is defined in the power outage policy section for each power source.

## 2.7.4 Power outage policy

These setting are in conjunction with the shutdown agents and control how the network module directs the shutdown of protected servers and appliances. It gives the possibility to prioritize and schedule shutdown actions so that the IT system is powered down in the correct order. For example, applications first, database servers next, and storage last. It is also possible to turn off some outlets to reduce power consumption and get longer battery runtime for the most important devices.

For examples on Powering down applications see the **Servicing the Network Management Module>>>Powering down/up applications examples** section.



## 2.7.4.1 On power outage

**On power outage, launch a sequential shutdown on:**

**Primary** with:  ▼

*by ending the shutdown sequence 30s before the end of backup time*

**Group 1** with:  ▼

*by starting the shutdown sequence*

when on battery for  s

OR

when the battery capacity is under  %

**Group 2** with:  ▼

*by starting the shutdown sequence*

when on battery for  s

OR

when the battery capacity is under  %

Policies are set per power source (outlet groups) if they are present in the UPS.

### 2.7.4.1.1 Enable/Disable

For each power source, the shutdown policy can be enabled or disabled with check-boxes.

When disabled, the policy will be greyed out.

### 2.7.4.1.2 Set the policy

The available policies for shutdown are listed below from preset to customized settings:

#### Preset policies

- Maximize availability — To end the shutdown 30s before the end of backup time.
- Immediate graceful shutdown — To start the shutdown after 30s of backup time.

#### Custom policies

When there are several conditions to start the shutdown sequence, the shutdown sequence will start as soon as one of the conditions is reached.

- Load shedding — To start the shutdown when on battery for the set time in (s) or when battery capacity reaches the set capacity in (%). When disabled, the condition is greyed out.
- Custom — Same as load shedding but with 2 additional options:
  - to end the shutdown after the set time in (s) before the end of backup time.
  - to start shutdown after the set time in (s) before the end of backup time.



When primary shuts OFF, both group1 and group 2 shut OFF immediately.  
So if Primary is set to one of the following:

- Immediate graceful shutdown — groups policies should be restricted to Immediate graceful shutdown.
- Load shedding — groups policies should avoid Maximize availability.



On custom policy, if the 2 checkboxes are unchecked, only the last condition is taken into account.

**Power source with**

by starting shutdown sequence

when on battery for  s

OR

when battery capacity is under  %

OR

by  sequence  s before the end of backup time

### 2.7.4.1.3 Settings examples

All the following examples are using below agent's settings.

Name	delay (s)	OS shutdown duration (s)
Local		<input type="text" value="120"/>
Agent 1	<input type="text" value="120"/>	<input type="text" value="90"/>
Agent2	<input type="text" value="90"/>	<input type="text" value="60"/>

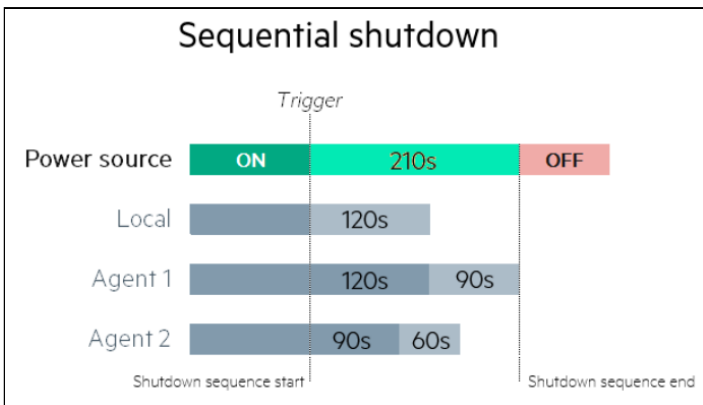

#### a Example 1: Maximize availability policy

**Power source with**

by ending shutdown sequence  s before the end of backup time

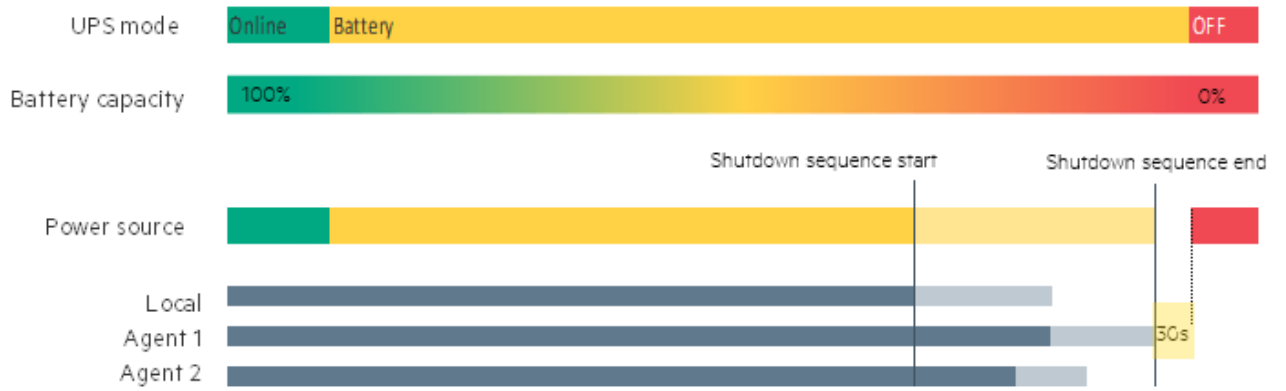

b Example 2: Immediate graceful shutdown policy

**Power source with** immediate graceful shutdown policy ▾  
by starting shutdown sequence after 10s

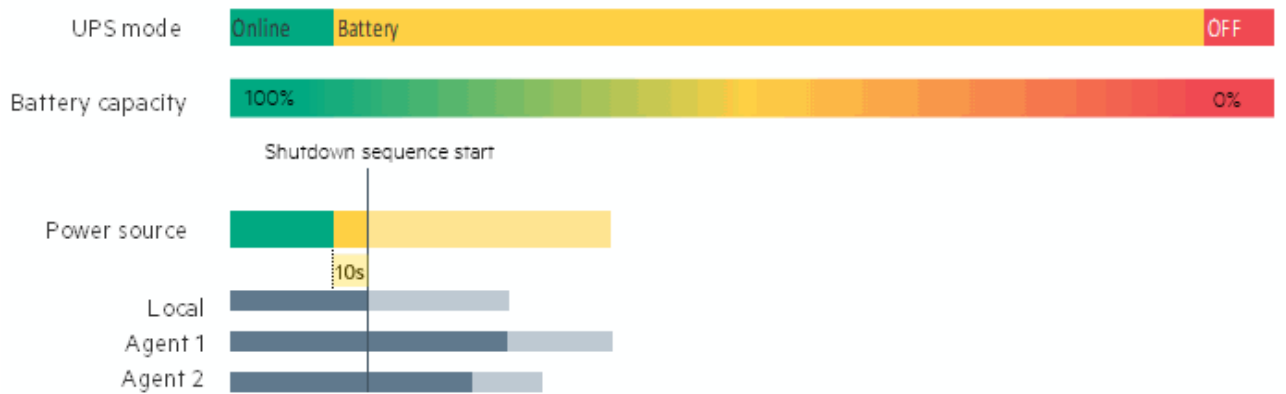

c Example 3: Load shedding policy

<p>Settings #1</p>	<p><input checked="" type="checkbox"/> <b>Power source with</b> <span>load shedding policy</span></p> <p>by starting shutdown sequence</p> <p><input checked="" type="checkbox"/> when on battery for <span>480 s</span></p> <p>OR</p> <p><input checked="" type="checkbox"/> when battery capacity is under <span>50 %</span></p> <p>UPS mode: Online Battery OFF</p> <p>Battery capacity: 100% 50% 0%</p> <p>Shutdown sequence start</p> <p>Power source: [Timeline]</p> <p>Local [Timeline]</p> <p>Agent 1 [Timeline]</p> <p>Agent 2 [Timeline]</p>
<p>Settings #2</p>	<p><input checked="" type="checkbox"/> <b>Power source with</b> <span>load shedding policy</span></p> <p>by starting shutdown sequence</p> <p><input checked="" type="checkbox"/> when on battery for <span>480 s</span></p> <p>OR</p> <p><input checked="" type="checkbox"/> when battery capacity is under <span>20 %</span></p> <p>UPS mode: Online Battery OFF</p> <p>Battery capacity: 100% 0%</p> <p>Shutdown sequence start</p> <p>Power source: [Timeline with 480s arrow]</p> <p>Local [Timeline]</p> <p>Agent 1 [Timeline]</p> <p>Agent 2 [Timeline]</p>

d Example 4: Custom policy

**Settings #1**

**Power source with** custom policy

by starting shutdown sequence

when on battery for 900 s

OR

when battery capacity is under 10 %

OR

by Starting sequence 240 s before the end of backup time

UPS mode: Online → Battery → OFF

Battery capacity: 100% → 0%

Shutdown sequence start: 240s before backup end

Power source: Local, Agent 1, Agent 2

**Settings #2**

**Power source with** custom policy

by starting shutdown sequence

when on battery for 900 s

OR

when battery capacity is under 10 %

OR

by Ending sequence 120 s before the end of backup time

UPS mode: Online → Battery → OFF

Battery capacity: 100% → 0%

Shutdown sequence end: 120s before backup end

Power source: Local, Agent 1, Agent 2

### 2.7.4.2 On low battery warning

**On low battery warning:**

Launch an **"immediate shutdown"** on all load segments

Immediate shutdown will cause all protected devices (agents) to shutdown simultaneously, delays set in the agent shutdown sequence timing have no effect.

In some cases, like a renewed power failure or failed battery, the capacity is much lower than anticipated. The UPS gives a Low battery warning when there is 2 - 3 minutes of estimated runtime left, depending on the UPS and its settings. This time is typically enough for shutting down a server but does not allow sophisticated sequential shutdown schemes. The Low battery policy is intended for these cases.

### 2.7.4.3 When utility comes back

**When utility comes back:**

Keep shutdown sequence running until the end and then restart (forced reboot)

Automatically restart the UPS when battery capacity exceeds  %

**Then Group 1** after  s

**Then Group 2** after  s

These settings define the restart sequence when utility comes back. For example, this allows sequential startup of the IT system so that network and storage devices are connected to 'Primary' and start up immediately. After a delay database servers in Group 1 are powered up, and then application and web servers in Group 2 are powered up. This startup would ensure that necessary services would be available for each layer when needed. A sequential startup will also help avoid a peak power draw in the beginning.

#### 2.7.4.3.1 Options

Keep shutdown sequence running until the end, and then restart (forced reboot).

Wait until UPS battery capacity exceeds a set percentage value in (%), and then automatically restart the UPS.

- Then restart Group 1 after a set time in (s).
- Then restart Group 2 after a set time in (s).

#### 2.7.4.3.2 Enable/Disable

Each option listed above can be enabled or disabled with check-boxes.

When disabled, the option will be greyed out.

## 2.8 Card

### 2.8.1 System information

System information is an overview of the main Network Module information.

The **COPY TO CLIPBOARD** button will copy the information to the clipboard.

#### 2.8.1.1 Identification

- System name – if filled, it replaces the UPS model name in the top bar
- Product
- Physical name
- Vendor
- UUID
- Part number
- Serial number
- Hardware version
- Location

- Contact

## 2.8.1.2 Firmware information

- Version
- SHA
- Build date
- Installation date
- Activation date
- Bootloader version

## 2.8.2 Resources

Card resources is an overview of the Network Module processor, memory and storage information.

### 2.8.2.1 Processor

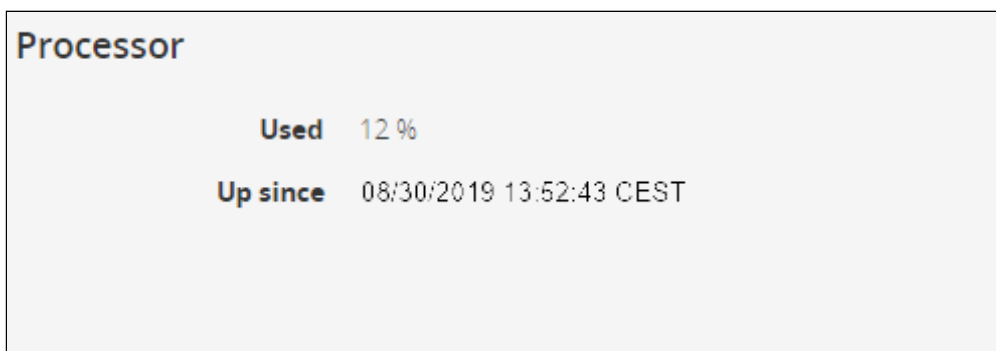

- Used in %
- Up since date

### 2.8.2.2 Memory

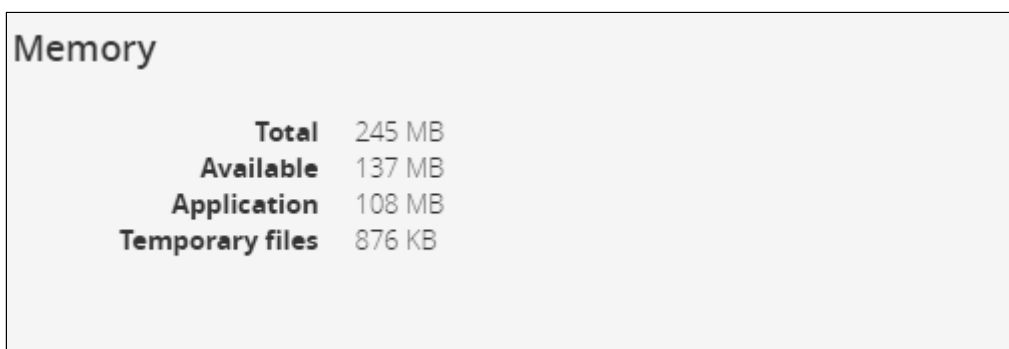

- Total size in MB
- Available size in MB
- Application size in MB
- Temporary files size in MB

### 2.8.2.3 Storage

#### Storage

<b>Total</b>	32 MB
<b>Available</b>	26 MB
<b>Used</b>	6 MB

- Total size in MB
- Available size in MB
- Used size in MB

### 2.8.3 System logs





#### System logs

Click on download button to choose system log files

[Download System Logs](#)

Press the **Download System Logs** button to select the log files to download.

#### Download System log files

Log File name	
Update	
Account	
Session	
System	

[Close](#)



For the list of system logs, see the [Information>>>System Logs codes](#) section.



## 2.8.4 Administration

### 2.8.4.1 Network module firmware

Network module firmware				
+ Upload				2 items
Status	Version	Release date	Installation date	Activation date
Active	1.2.0	03/07/2018	03/07/2018	03/07/2018
Valid	1.1.2	02/09/2018	02/09/2018	02/09/2018

- Monitors the information for the two-embedded firmware.
- Upgrade the Network Module firmware.

#### 2.8.4.1.1 Firmware information

##### a Status

- Uploading
- Invalid
- Valid
- Pending reboot
- Active

##### b Version

Displays the associated firmware version.

##### c Release date

Displays the release date of the firmware.

For better performance, security, and optimized features, Eaton recommends to upgrade the Network Module regularly.

##### d

##### Installation date

Displays when the firmware was installed in the Network Module.

##### e Activation date

Displays when the firmware was activated in the Network Module.

#### 2.8.4.1.2 Upgrade the Network Module firmware

During the upgrade process, the Network Module does not monitor the UPS Product status.

To upgrade the firmware:

1. Download the latest firmware version from the website. For more information, see the *Servicing the Network Management Module* >>> *Accessing to the latest Network Module firmware/driver* section .

2. Click **+Upload**.
3. Select the firmware package by navigating to the folder where you saved the downloaded firmware.
4. Click **Upload**. The upload can take up to 5 minutes.
  - The firmware that was inactive will be erased by this operation.
  - When an upgrade is in progress, the upload button is disabled, and the progress elements appear below the table with the following steps:  
Transferring > Verifying package > Flashing > Configuring system > Rebooting

A confirmation message displays when the firmware upload is successful, and the UPS Network Module automatically restarts.

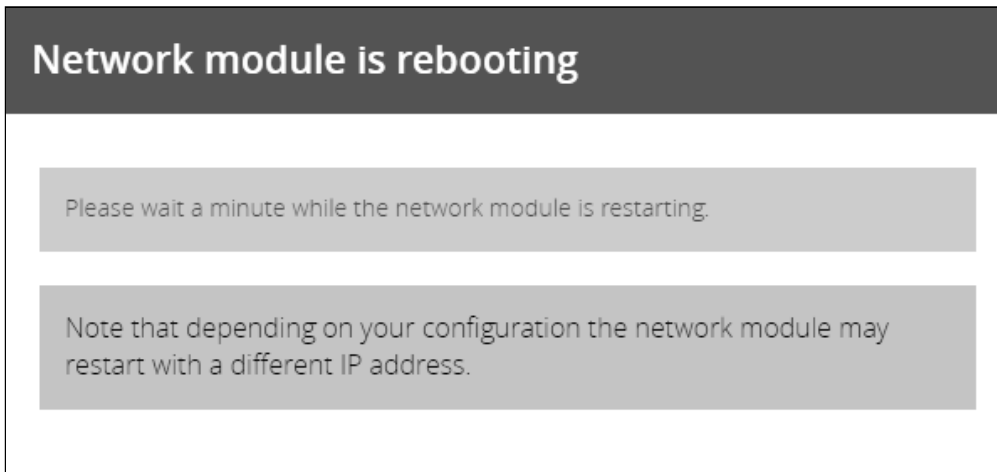

*Do not close the web browser or interrupt the operation.  
Depending on your network configuration, the Network Module may restart with a different IP address.  
Refresh the browser after the Network module reboot time to get access to the login page.  
Press F5 or CTRL+F5 to empty the browser to get all the new features displayed on the Web user interface.  
Communication Lost and Communication recovered may appear in the Alarm section.*

## 2.8.4.2 Sanitization

Sanitization removes all the data; the Network Module will come back to factory default settings.



For details on default settings, see the *Information>>>Default settings parameters* section .

To sanitize the Network Module:

- Click **Sanitize**.

A confirmation message displays, click **Sanitize** to confirm.

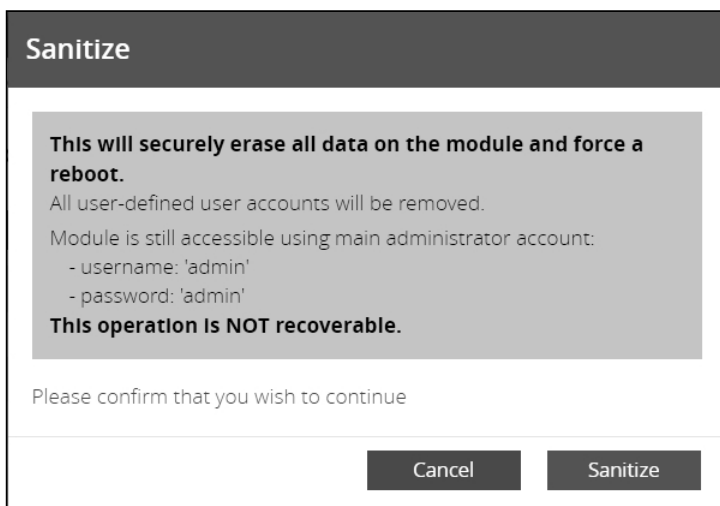

*Depending on your network configuration, the Network Module may restart with a different IP address. Only main administrator user will remain with default login and password. Refresh the browser after the Network module reboot time to get access to the login page.*

### 2.8.4.3 Reboot

Reboot means restarting the network module operating system.

To reboot the Network Module:

- Click **Reboot**.

A confirmation message displays, click **Continue** to confirm, the reboot time will take approximately less than 2min.

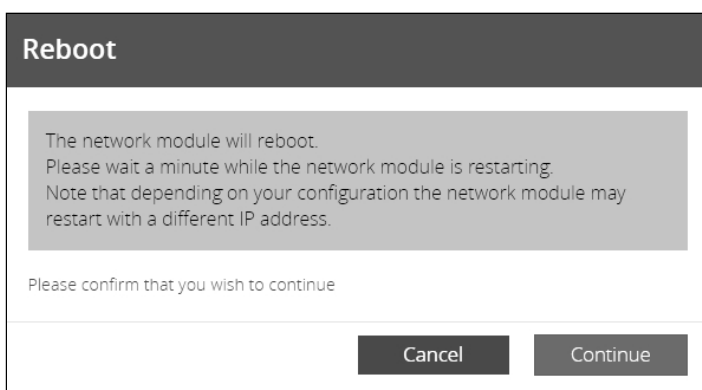

*Depending on your network configuration, the Network Module may restart with a different IP address. Refresh the browser after the Network module reboot time to get access to the login page. Communication Lost and Communication recovered may appear in the Alarm section.*

### 2.8.4.4 Maintenance

The maintenance report is for the service representative use to diagnose problems with the network module. It is not intended for the user, which is why the file is protected by a password. None of the network module users or network information are extracted.

To download the maintenance report file:

- Click **Download report**.

A confirmation message displays, Maintenance report file successfully downloaded.

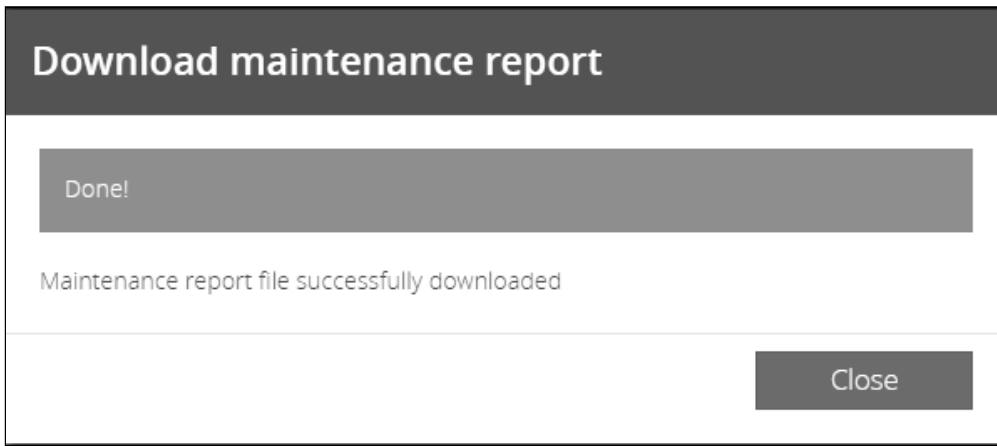

### 2.8.4.5 Settings

Allow to save and restore the Network module settings.



For more details, navigate to *Servicing the Network Management Module* >>> *Saving/Restoring/Duplicating* Network module configuration settings.

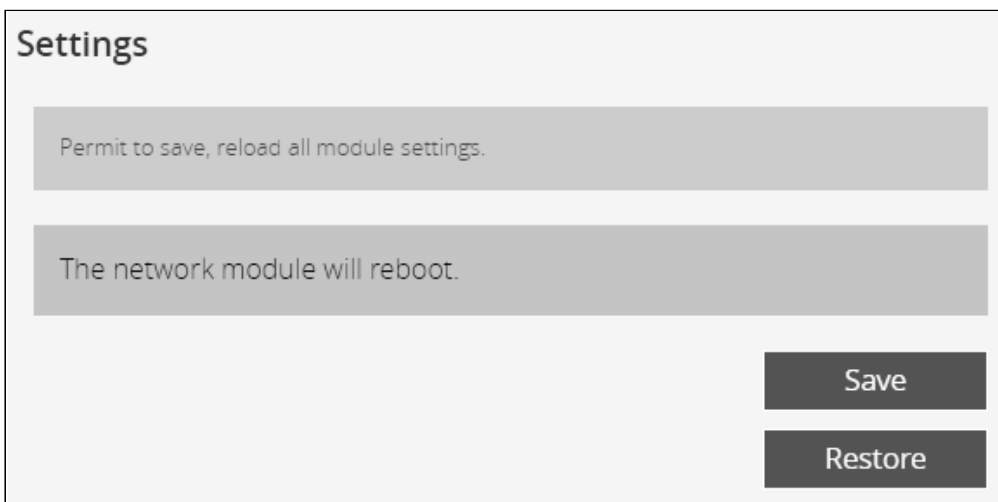

#### 2.8.4.5.1 Save



Below settings are not saved:  
Local users other than the main administrator  
Sensor settings (commissioning, alarm configuration)

**Save**

Excluding settings:

Network

---

Cancel
Continue

To save the Network module settings:

- Click on **Save**
- Select to include the Network settings if needed.
- A passphrase need to be entered twice to cypher the sensitive data.
- Click on **Continue**

### 2.8.4.5.2 Restore

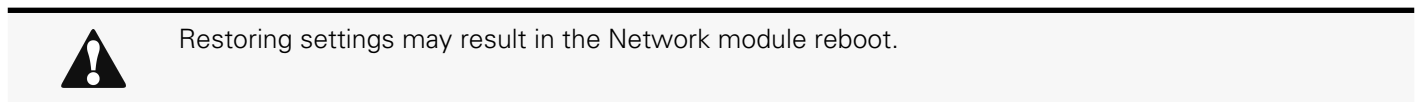

**Restore**

**This action is not recoverable.**  
The network module will reboot.

Excluding settings:

Network

---

Cancel
Continue

To restore the Network module settings:

- Click on **Restore**
- Select to include the Network settings if needed.
- Click on **Continue**
- Select the JSON file
- If sensitive data are detected, enter the passphrase used when the file was saved.
- Click again on **Continue** to confirm

## 2.8.5 Commissioning (sensors)

### 2.8.5.1 Sensors commissioning table

Sensor commissioning 3 items

Discover Delete Define offsets

<input type="checkbox"/>	Name	Location	Temperature	Humidity	Dry contact #1	Dry contact #2	Communication	
<input checked="" type="checkbox"/>	EMPDT1H1C2 @3	Lab_TOP	23.7°C	35.8%	Lab_FRONT_DOOR	Lab_REAR_DOOR	Connected <small>Since 06/22/2018 19:57:49 CEST</small>	
<input type="checkbox"/>	EMPDT1H1C2 @15	Lab_MIDDLE	23.3°C				Connected <small>Since 06/22/2018 19:57:48 CEST</small>	

The table displays the sensors commissioning information and includes the following details.

- **Name**
- **Location** – location-position-elevation
- **Temperature**
- **Humidity**
- **Dry contact #1** – Status and name
- **Dry contact #2** – Status and name

Polarity set	Current state	Dry contact status
Normally open	open	
Normally open	closed	
Normally closed	closed	
Normally closed	open	

- **Communication** – Connected/Lost with dates

### 2.8.5.2 Actions

#### 2.8.5.2.1 Discover

At first the table is empty, press the **Discover** button to launch the sensor discovery process.

If sensors are discovered, the table is populated accordingly

#### 2.8.5.2.2 Delete

Select a sensor and press the **Delete** button to delete the sensor.

When a sensor is deleted, all the commissioning information are deleted.

### 2.8.5.2.3 Define offsets

Select the sensors.

Press the **Define offset** button to adjust the temperature and humidity offsets of the selected sensors.

Extend the temperature or humidity section.

Set the offsets in the cell, temperatures and humidity will be updated accordingly.

Press the **Save** button when done.

## Define offsets

**Temperature** ▼

EMPDT1H1C2 @3	<input type="text" value="-1.1"/>	23.7 °C
EMPDT1H1C2 @15	<input type="text" value="0"/>	23.3 °C

**Humidity** ▼

EMPDT1H1C2 @3	<input type="text" value="0"/>	35.9 %
---------------	--------------------------------	--------



Deactivated humidity or temperatures are not displayed.

2.8.5.2.4 Edit 

**Sensor commissioning**

Product	Eaton EMPDT1H1C2
Part number	EMPDT1H1C2
Serial number	GB13H37003
Name	<input type="text" value="EMPDT1H1C2@3"/>
<b>↓ Location</b>	▼
Location	<input type="text" value="Lao_TOP"/>
<b>🔗 Temperature &amp; Humidity</b>	▼
<b>Temperature</b>	
Active	<input type="text" value="Yes"/>
Name	<input type="text" value="EMPDT1H1C2@3-T1"/>
<b>Humidity</b>	
Active	<input type="text" value="Yes"/>
Name	<input type="text" value="EMPDT1H1C2@3-H1"/>
<b>🔗 Dry contacts</b>	▼
<b>Dry contact #1</b>	
Active	<input type="text" value="No"/>
Name	<input type="text" value="Lao_FRONT_DOOR"/>
Polarity	<input type="text" value="Normally open"/>
<b>Dry contact #2</b>	
Active	<input type="text" value="Yes"/>
Name	<input type="text" value="Lao_REAR_DOOR"/>
Polarity	<input type="text" value="Normally open"/>

Press the pen logo to edit sensor communication information and access to the following information and settings:

- Product reference
- Part number
- Serial number
- Name
- Location
- Temperature and humidity – Active (Yes, No)
- Dry contacts – Active (Yes, No)/Name/Polarity (Normally open, Normally closed)



Press **Save** after modifications.

### 2.8.5.3 Note:



If the UPS provides temperature compensated battery charging option, see the *Servicing the EMP>>>Using the EMP for temperature compensated battery charging* section

## 2.9 Sensors

### 2.9.1 Status (sensors)



Humidities, temperatures or dry contacts deactivated during commissioning are not displayed.

#### 2.9.1.1 Temperature table

Temperature			
Name	Location	Current	Communication
EMPDT1H1C2 @3-T1	Lab_TOP	23.0°C	Connected <small>Since 06/22/2018 19:57:49 CEST</small>
EMPDT1H1C2 @15-T1	Lab_MIDDLE	23.4°C	Lost <small>Since 06/27/2018 16:16:27 CEST</small>
EMPDT1H1C2 @24-T1	Lab_BOTTOM	23.0°C	Connected <small>Since 06/22/2018 19:57:49 CEST</small>

The table shows the following information for each sensor:

- Name
- Location
- Current temperature
- Communication – Connected/Lost with dates



#### 2.9.1.2 Humidity table

Humidity			
Name	Location	Current	Communication
EMPDT1H1C2 @3-H1	Lab_TOP	37.8%	Connected <small>Since 06/22/2018 19:57:49 CEST</small>

The table shows the following information for each sensor:





- Name
- Location
- Current humidity
- Communication – Connected/Lost with dates

### 2.9.1.3 Dry contacts table

Dry contacts			
Name	Location	Status	Communication
Lab_FRONT_DOOR	Lab_TOP	 Since 06/26/2018 11:32:02 CEST	Connected Since 06/22/2018 19:57:49 CEST
Lab_REAR_DOOR	Lab_TOP	 Since 06/26/2018 11:32:02 CEST	Connected Since 06/22/2018 19:57:49 CEST

The table shows the following information for dry contacts:

- Name
- Location
- Status with date:

Polarity set	Current state	Dry contact status
Normally open	open	
Normally open	closed	
Normally closed	closed	
Normally closed	open	

- Communication – Connected/Lost with dates

## 2.9.2 Alarm configuration (sensors)



Humidity, temperatures or dry contacts deactivated during commissioning are not displayed.

### 2.9.2.1 Temperature

Temperature								
Name	Location	Enabled	Low critical	Low warning	Measure	High warning	High critical	Hysteresis
EMPDT1H1C2 @3-T1	Lab_TOP	<input checked="" type="checkbox"/>	<input type="text" value="10"/>	<input type="text" value="15"/>	22.9°C	<input type="text" value="50"/>	<input type="text" value="55"/>	<input type="text" value="1"/>
EMPDT1H1C2 @15-T1	Lab_MIDDLE	<input checked="" type="checkbox"/>	<input type="text" value="10"/>	<input type="text" value="15"/>	23.4°C	<input type="text" value="50"/>	<input type="text" value="55"/>	<input type="text" value="1"/>
EMPDT1H1C2 @24-T1	Lab_BOTTOM	<input checked="" type="checkbox"/>	<input type="text" value="10"/>	<input type="text" value="15"/>	23.0°C	<input type="text" value="50"/>	<input type="text" value="55"/>	<input type="text" value="1"/>

The table shows the following information and settings for each sensor:

- Name
- Enabled – yes/no
- Low critical threshold – xx°C or xx°F
- Low warning threshold – xx°C or xx°F
- Current temperature
- High warning threshold – xx°C or xx°F

- High critical threshold – xx°C or xx°F
- Hysteresis – x°C or x°F

### 2.9.2.1.1 Actions

#### a Set Enabled

Select and directly change the setting in the table and then **Save**.

When disabled, no alarm will be sent.

#### b Set alarm threshold

Select and directly change the setting in the table and then **Save**.

When a warning threshold is reached, an alarm will be sent with a warning level.

When a critical threshold is reached, an alarm will be sent with a critical level.

#### c Set Hysteresis

Select and directly change the setting in the table and then **Save**.

The hysteresis is the difference between the value where the alarm turns ON from turning OFF and the value where it turns OFF from turning ON.

## 2.9.2.2 Humidity

Humidity									
Name	Location	Enabled	Low critical	Low warning	Measure	High warning	High critical	Hysteresis	
EMPDT1H1C2 @3-H1	Lab_TOP	<input checked="" type="checkbox"/>	<input type="text" value="10"/>	<input type="text" value="20"/>	37.5%	<input type="text" value="60"/>	<input type="text" value="70"/>	<input type="text" value="1"/>	

**Save**

The table shows the following information and settings for each sensor:

- Name
- Enabled – yes/no
- Low critical threshold – xx%
- Low warning threshold – xx%
- Current humidity
- High warning threshold – xx%
- High critical threshold – xx%
- Hysteresis – x%

### 2.9.2.2.1 Actions

#### a Set Enabled

Select and directly change the setting in the table and then **Save**.

When disabled, no alarm will be sent.

#### b Set alarm threshold

Select and directly change the setting in the table and then **Save**.

When a warning threshold is reached, an alarm will be sent with a warning level.

When a critical threshold is reached, an alarm will be sent with a critical level.

### c Set Hysteresis

Select and directly change the setting in the table and then **Save**.

The hysteresis is the difference between the value where the alarm turns ON from turning OFF and the value where it turns OFF from turning ON.

## 2.9.2.3 Dry contacts

Dry contacts			
Name	Location	Enabled	Alarm severity
Lab_FRONT_DOOR	Lab_TOP	<input checked="" type="checkbox"/>	Info
Lab_REAR_DOOR	Lab_TOP	<input checked="" type="checkbox"/>	Info

**Save**

The table shows the following settings for each dry contact:

- Name
- Enabled – yes/no
- Alarm severity – Info/Warning/Critical

### 2.9.2.3.1 Actions

#### a Set Enabled

Select and directly change the setting in the table and then **Save**.

When disabled, no alarm will be sent.

#### b Set alarm severity

Select and directly change the setting in the table and then **Save**.

Dry contacts alarm will be sent at the selected level.

## 2.9.2.4 Default settings parameters and limitations



For details on default parameters and limitations, see the *Information>>>Default settings parameters* section

## 2.9.3 Information (sensors)

Sensor information is an overview of all the sensors information connected to the Network Module.

**EMPDT1H1C2 @1**

**Physical name** Eaton EMPDT1H1C2  
**Vendor** *Eaton*  
**Part number** EMPDT1H1C2  
**Firmware version** 01.02.0009  
**UUID** c9fe1f8afd5050ddba7f624e754b6e9c  
**Serial number** GB13J28274  
**Location** -

- Physical name
- Vendor
- Part number
- Firmware version
- UUID
- Serial number
- Location

## 2.10 Legal information (footer)

This Eaton network module includes software components, which are licensed under various open source licenses, or under a proprietary license.

[Availability of source code](#)

[Notice for proprietary elements](#)

Component	
libnetconf2	libnetconf2 is licensed under the GNU General Public License (GPL) version 2.0.
libyang	libyang is licensed under the GNU General Public License (GPL) version 2.0.

This Network Module includes software components that are either licensed under various open source license, or under a proprietary license.

### 2.10.1 Component list

All the open source components included in the Network Module are listed with their licenses.

### 2.10.2 Notice for our proprietary (i.e. non-Open source) elements

Provides notice for our proprietary (i.e. non-Open source) elements.

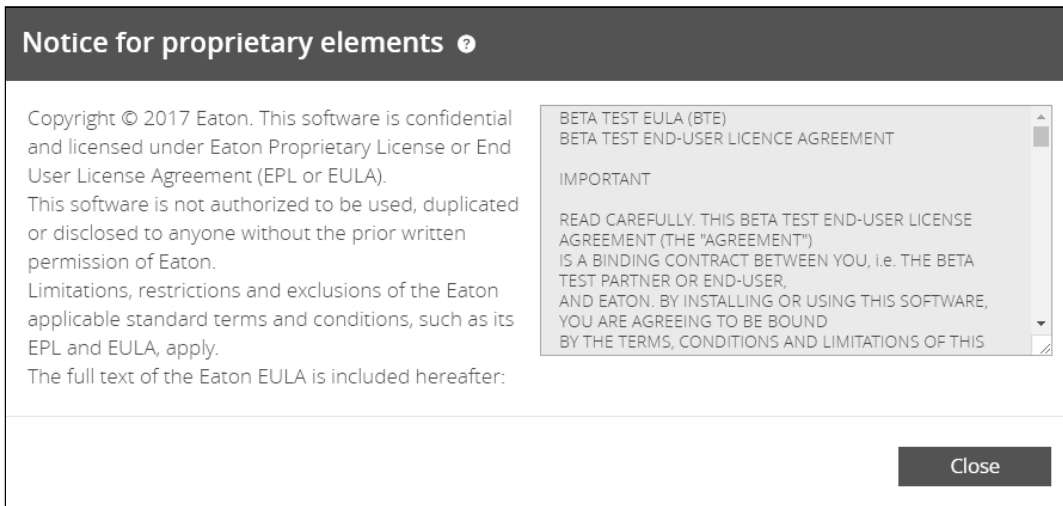

### 2.10.3 Availability of source code

Provides the way to obtain the source code of open source components that are made available by their licensors.

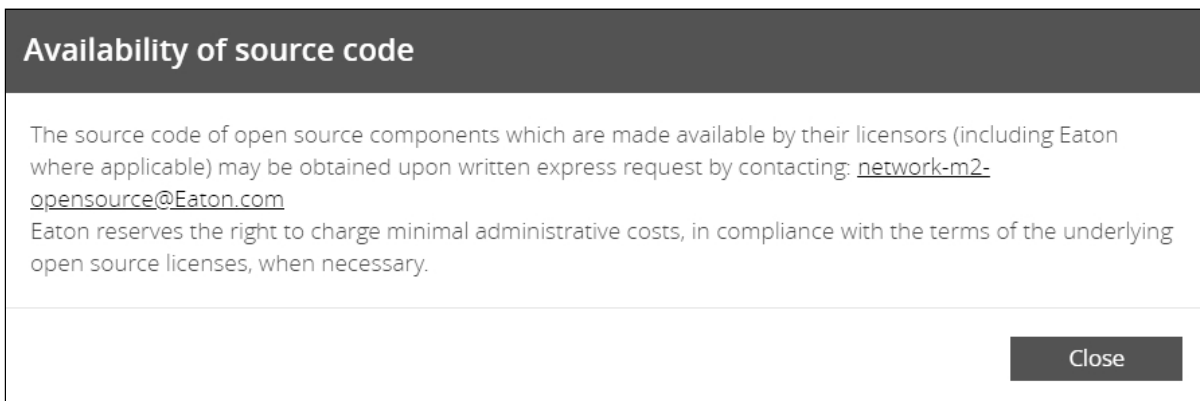

## 2.11 Contextual help and full documentation

### 2.11.1 Access to contextual help

Press ? icon on the top right side of the page to access the contextual help.



Contextual help can be closed by pressing the X icon on the top right of the page.

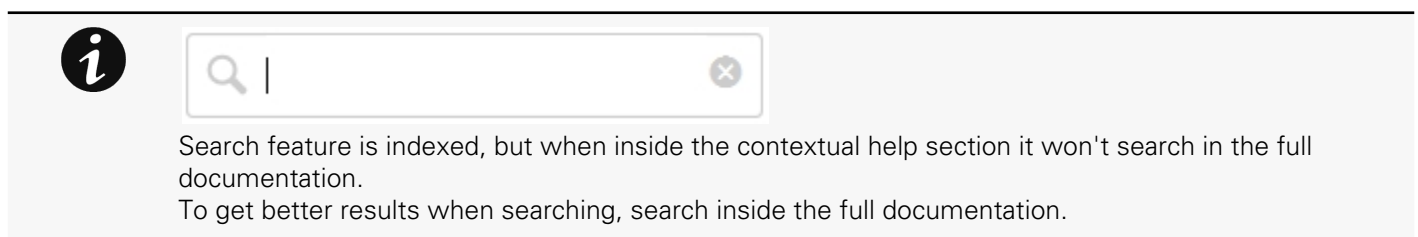

### 2.11.2 Access to full documentation

Press ? icon on the top right side of the page to access the contextual help.



In the contextual help section, press the **Full documentation** button on the top right to access the full documentation in a new window.

**Full documentation** 

You can then navigate into below sections:

- Contextual help
- Servicing the Network Management Module
- Securing the Network Management Module
- Information
- Troubleshooting

## 3 Servicing the Network Management Module

### 3.1 Unpacking the Network module

The network module will include the following:

- Network module
- QuickStart
- USB AM to Micro USB/M/5P 5ft Cable



Packing materials must be disposed of in compliance with all local regulations concerning waste. Recycling symbols are printed on the packing materials to facilitate sorting.

### 3.2 Installing the Network Module

#### 3.2.1 Mounting the Network Module



It is not necessary to power down the UPS before installing the Network Module. Required tools: No. 2 Phillips screwdriver.

The Network Module is hot-swappable. Inserting and/or extracting the Network Module from the communication slot of the product has no effect on the output.

Remove the two screws securing the option slot cover plate and store the plate for possible future use.

- Install the Network Module along the alignment channels in the option slot.
- Secure the Network Module using the two screws.



- If the product is powered up, you can verify that the Network Module is seated properly and communicating with the product by checking that the Status ON LED flashes green after 2 minutes.

### 3.3 Accessing the Network Module

#### 3.3.1 Accessing the web interface through Network

##### 3.3.1.1 Connecting the network cable



Security settings in the Network Module may be in their default states. For maximum security, configure through a USB connection before connecting the network cable.



Connect a standard *gigabit compatible shielded ethernet cable (F/UTP or F/FTP)* between the network connector on the Network Module and a network jack.

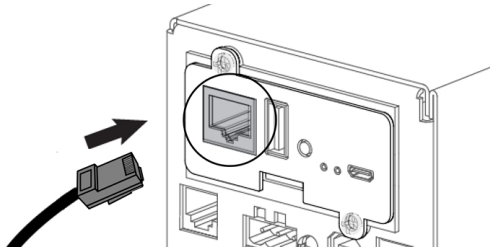

### 3.3.1.2 Accessing the web interface



It is highly recommended that browser access to the Network Module is isolated from outside access using a firewall or isolated network.

1. On a network computer, launch a supported web browser. The browser window appears.
2. In the Address/Location field, enter: `https://xxx.xxx.xxx.xxx`, where `xxx.xxx.xxx.xxx` is the static IP address of the Network Module.  
The log in screen appears.
3. Enter the user name in the User Name field. The default user name is **admin**.
4. Enter the password in the Password field. The default password is **admin**.  
The password must be changed at first login.
5. Click **Sign In**. The Network Module web interface appears.

## 3.3.2 Finding and setting the IP address

### 3.3.2.1 Your network is equipped with a BOOTP/DHCP server (default)

#### 3.3.2.1.1 Read from the device LCD



Note: some older UPS may not be able to display the IP address even if they have an LCD. Please consult the UPS manual.

If your device has an LCD, from the LCD's menu, navigate to Identification>>>"COM card IPv4".

- Note the IP address of the card.
- Go to the section: Accessing the web interface through Network.

#### 3.3.2.1.2 With web browser through the configuration port

For example, if your device does not have an LCD, the IP address can be discovered by accessing the web interface through RNDIS and browsing to Settings>Network.

To access the web interface through RNDIS, see the [Accessing the web interface through RNDIS](#) section.

- Navigate to Settings>>>Network>>>IPv4.
- Read the IPv4 settings.

### 3.3.2.2 Your network is not equipped with a BOOTP/DHCP server

#### 3.3.2.2.1 Define from the configuration port

The IP address can be defined by accessing the web interface through RNDIS.

To access web interface through RNDIS, see the [Accessing the web interface through RNDIS](#) section.

Define the IP settings:

- Navigate to Settings>>>Network>>>IPV4.
- Select Manual (Static IP).
- Input the following information: Address, Subnet Mask, Default Gateway
- Save the changes.

### 3.3.3 Accessing the web interface through RNDIS

#### 3.3.3.1 Connecting the configuration cable

1. Connect the Micro-B to USB cable to a USB connector on the host computer.
2. Connect the cable to the Settings connector on the Network Module.

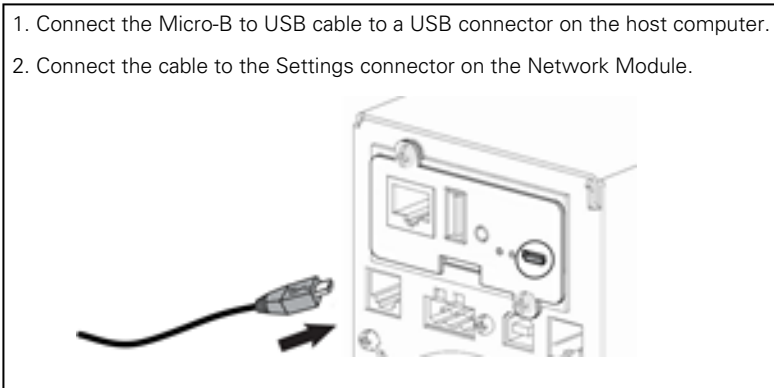

This connection is used to access and configure the Network Module network settings locally through a RNDIS (Ethernet over USB interface).

#### 3.3.3.2 Web interface access through RNDIS

##### 3.3.3.2.1 Configuring the RNDIS

###### a Automatic configuration



RNDIS driver is used to emulate a network connection from USB. After the card is connected to the PC, **Windows**® OS will automatically search for the RNDIS driver. On some computers, the OS can find the RNDIS driver then configuration is completed, and you can go to Accessing the web interface. On some others it may fail then proceed to manual configuration.

###### b Manual configuration

1. In case **Windows**® OS fails to find driver automatically, go to the Windows control panel>Network and sharing center>Local area connection

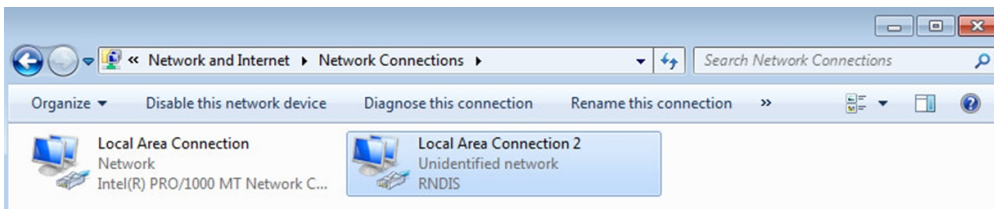

2. Right click on the RNDIS local area connection and select Properties.

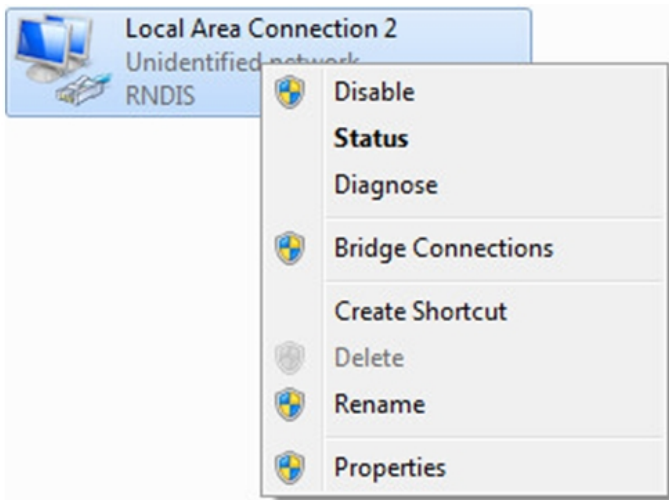

3. Select Internet Protocol Version 4 (TCP/IPv4) and press the Properties button.

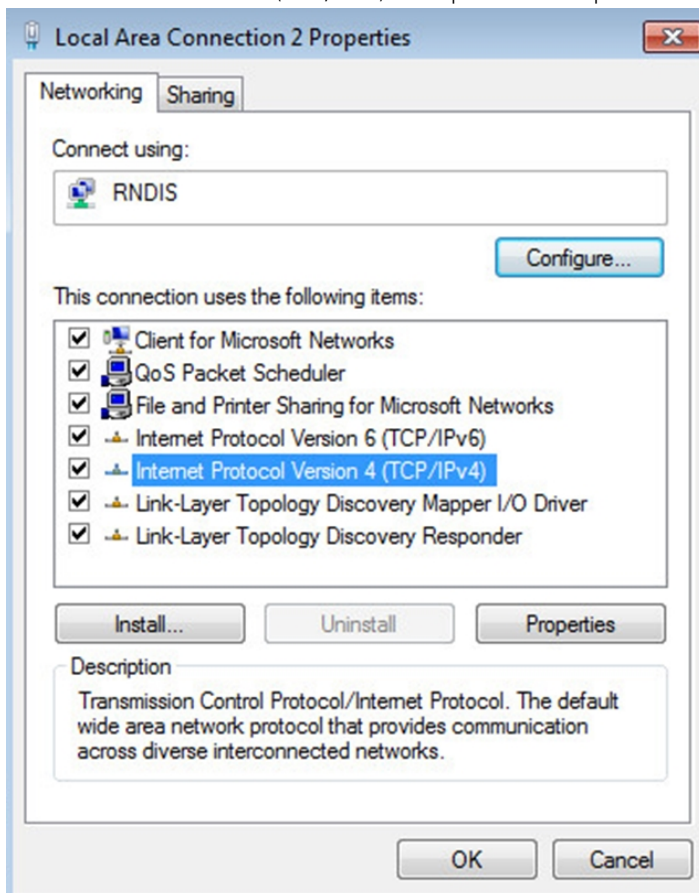

4. Then enter the configuration as below and validate (IP = 169.254.0.150 and mask = 255.255.255.0), click OK, then click on Close.

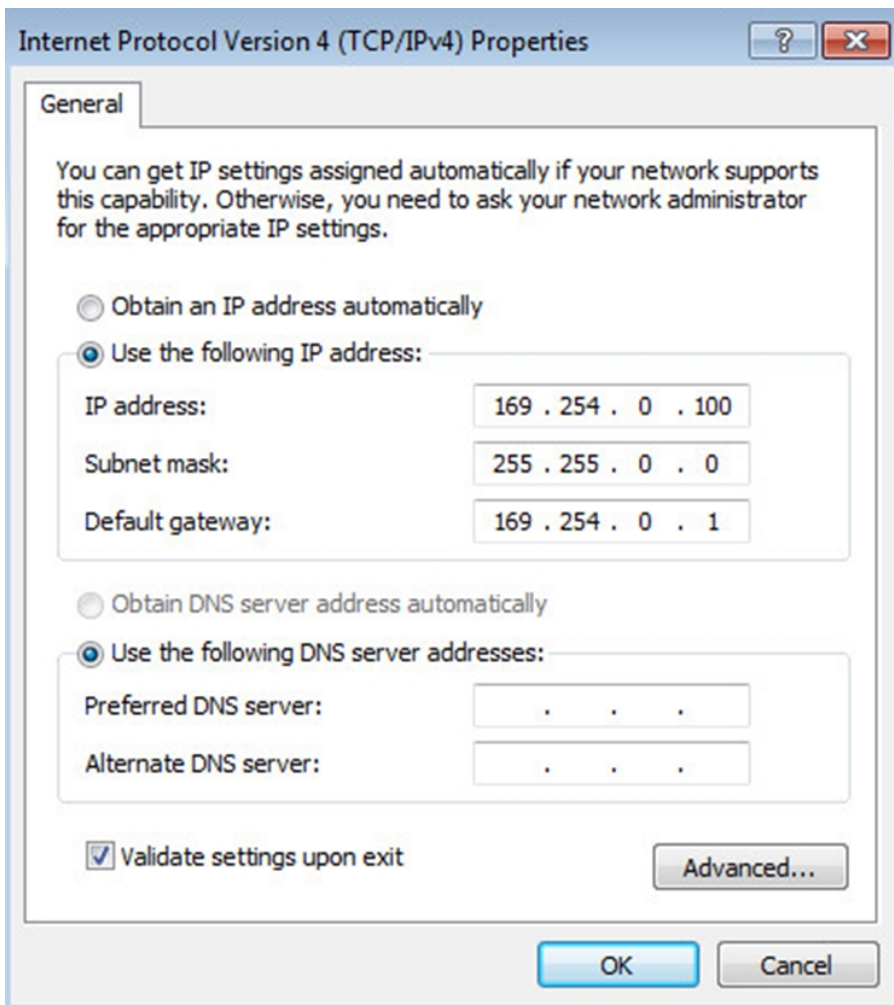

### 3.3.3.2.2 Accessing the web interface

1. Be sure that the UPS is powered on.
2. On the host computer, download the rndis.7z file from the website [www.eaton.com/downloads](http://www.eaton.com/downloads) and extract it. For more information, navigate to [Accessing to the latest Network Module firmware/driver](#) section.
3. Launch setProxy.bat to add 169.254.\* in proxy's exceptions list, if needed. For manual configuration, navigate to Modifying the Proxy exception list section in the full documentation.
4. Launch a supported browser, the browser window appears.
5. In the Address/Location field, enter: **https://169.254.0.1**, the static IP address of the Network Module for RNDIS. The log in screen appears.
6. Enter the user name in the User Name field. The default user name is **admin**.
7. Enter the password in the Password field. The default password is **admin**.
8. Click **Sign In**. The Network Module local web interface appears.

## 3.3.4 Accessing the card through serial terminal emulation

### 3.3.4.1 Connecting the configuration cable

1. Connect the Micro-B to USB cable to a USB connector on the host computer.
2. Connect the cable to the Settings connector on the Network Module.

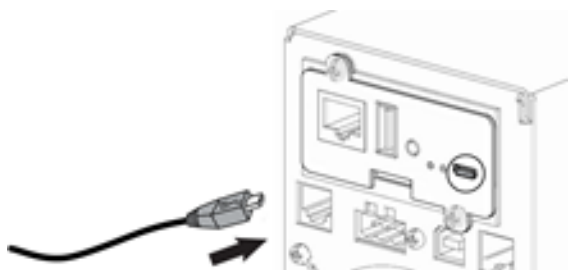

This connection is used to access and configure the Network Module network settings locally through Serial (Serial over USB interface).

### 3.3.4.2 Manual configuration of the serial connection



Serial driver is used to emulate a serial connection from USB. After the card is connected to the PC, manual configuration of the driver is needed for **Windows**® OS to discover the serial connection.

1. On the host computer, download the rndis.7z file from the website [www.eaton.com/downloads](http://www.eaton.com/downloads) and extract it.
2. Plug the USB cable and go to **Windows**® Device Manager.
3. Check the CDC Serial in the list, if it is with a yellow exclamation mark implying that driver has not been installed follow the steps 4-5-6-7 otherwise configuration is OK.

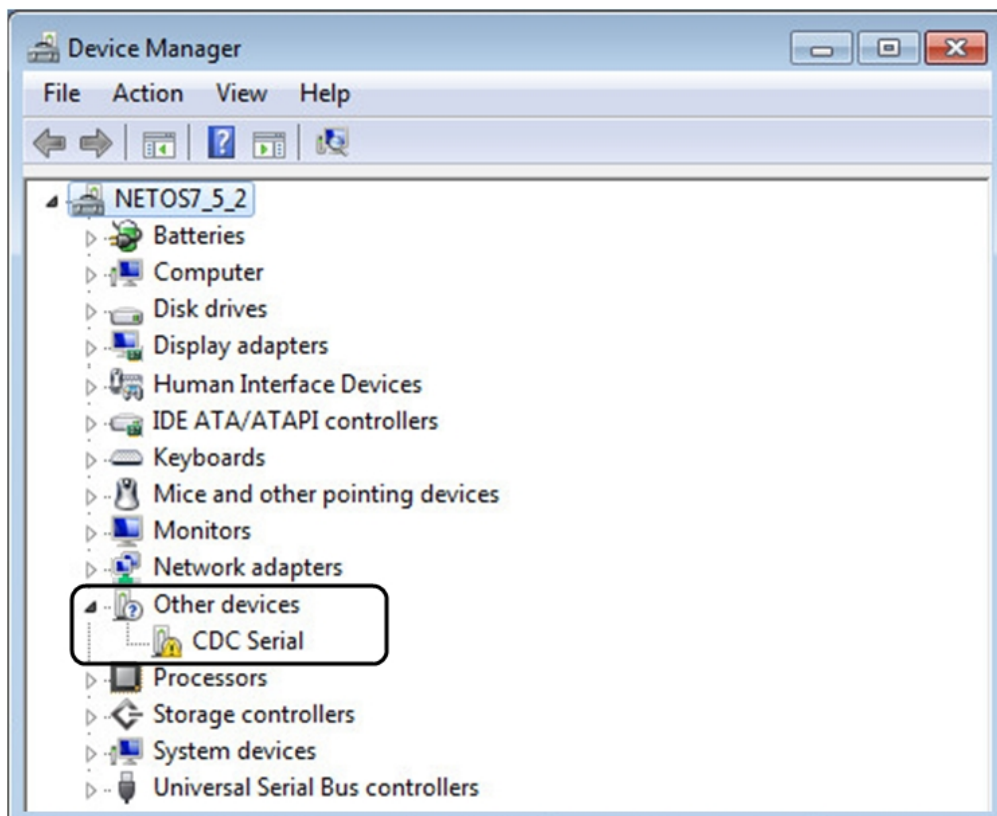

4. Right click on it and select Update Driver Software. When prompted to choose how to search for device driver software, choose Browse my computer for driver software. Select Let me pick from a list of device drivers on my computer.
5. Select the folder where you have previously downloaded the driver file Click on Next.
6. A warning window will come up because the driver is not signed. Select Install this driver software anyway
7. The installation is successful when the COM port number is displayed for the Gadget Serial device in the **Windows**® Device Manager.

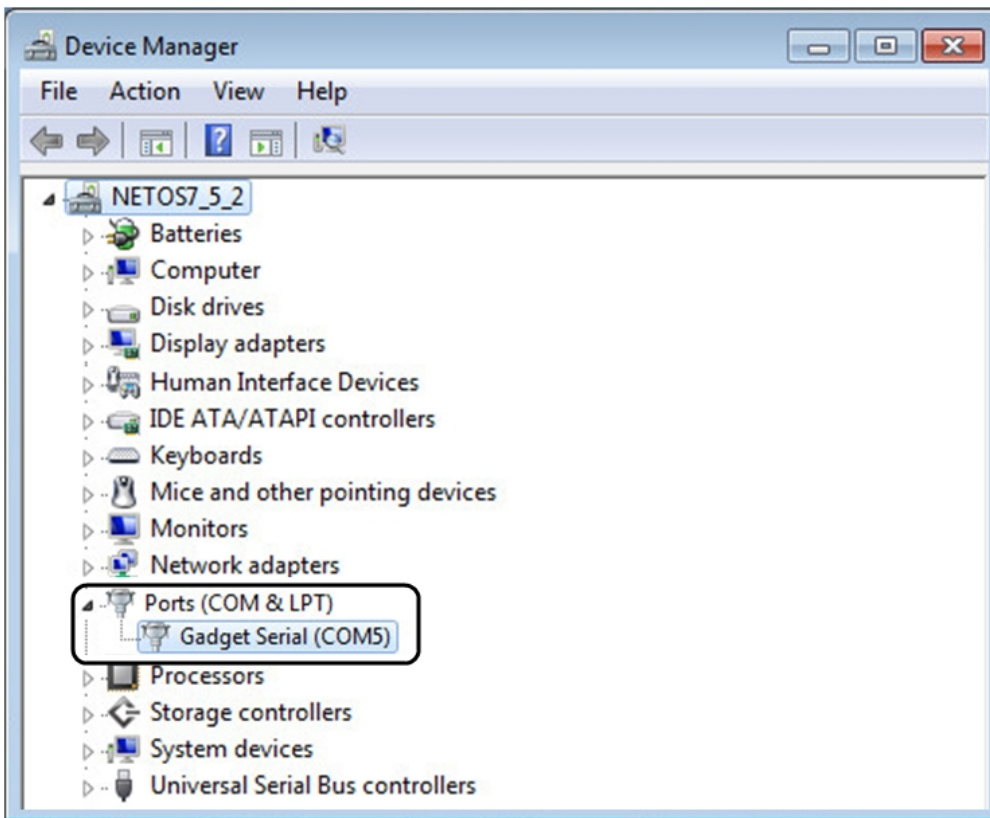

### 3.3.4.3 Accessing the card through Serial

CLI can be accessed through:

- SSH
- Serial terminal emulation.

It is intended mainly for automated configuration of the network and time settings of the network card. It can also be used for troubleshooting and remote reboot/reset of the network interface in case the web user interface is not accessible.



Changing network parameters may cause the card to become unavailable remotely. If this happens it can only be reconfigured locally through USB.



You can see this list of available commands by typing in the CLI: `?`  
You can see the help by typing in the CLI: `help`

### 3.3.5 Modifying the Proxy exception list

To connect to the Network Module via a USB cable and your system uses a Proxy server to connect to the internet, the proxy settings can reject the IP address 169.254.0.1.

The 169.254.\* Sequence is used to set up communication with devices via a physical connection.

To activate this connection, exceptions will have to be made in the proxy settings.

- Open Internet Explorer
- Navigate to settings, Internet options;

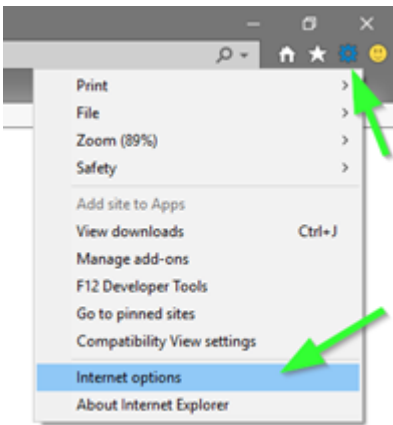

- Select the Connections tab
- Press LAN Settings

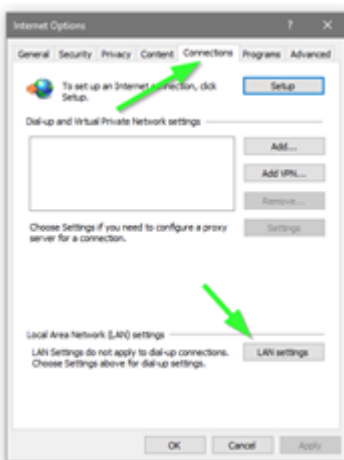

- Press ADVANCED



- Add the address 169.254.\*



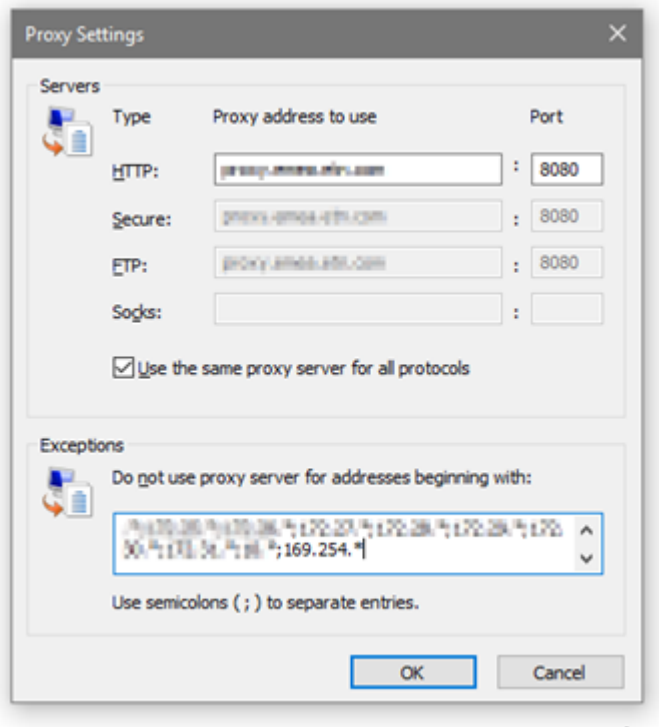







- Press OK.
- Close Internet Explorer and re-open it.
- Now you can access the address 169.254.0.1 with Internet Explorer and any other browser.



### 3.4 Configuring the Network Module settings

Use Eaton UPSNetwork Module web interface to configure the UPS Network Module.

Main web interface menus are described below:

	Home page with overview of the UPS/Module status (Synoptic with measures, Active alarms, Meters, Outlet status,...).
	Module settings (Date&Time, Users, Network, Protocols, Certificates, Email, My Preferences, ...).
	List of Alarms with date, time and description.
	Power quality meters, Battery information and measure logs.
	Entire UPS Control, Battery test, Outlets control.
	Scheduled Shutdown, Agents list, Agent Settings, Power Outage Policy.



	Sensors (only displayed when sensors have been discovered in card administration)
	Card administration (Firmware upgrade, reboot, save and restore, commissioning,...)

## 3.5 Configuring/Commissioning/Testing LDAP

### 3.5.1 Commissioning

Refer to the section [Contextual Help>>>Settings>>>Users](#) to get help on the configuration.

#### 3.5.1.1 Configuring connection to LDAP database

This step configures the LDAP client of the network module to request data from an LDAP base.

1. Activate LDAP.
2. Define security parameters according to LDAP servers' requirements.
3. Configure primary server (and optionally a secondary one).
4. If security configuration needs server certificate verification, import your LDAP server certificate.  
Refer to the section [to get help on certificate import](#).
  - a. In case LDAP server certificate is self-signed, import the self-signed certificate in the *Trusted remote certificate list for LDAP service*.
  - b. In case LDAP server certificate has been signed by a CA, import the corresponding CA in the *Certificate authorities (CA) list for LDAP service*.
5. Configure credentials to bind with the LDAP server or select *anonymous* if no credentials are required.
6. Configure the *Search base DN*.
7. Configure the request parameters (see examples below).

##### 3.5.1.1.1 Typical request parameters

Parameter	OpenLDAP	Active Directory™ with POSIX account activated	Active Directory™
User base DN	ou=users, dc=example, dc=com	ou=users, dc=example, dc=com	ou=users, dc=example, dc=com
User name attribute	uid	uid	sAMAccountName
UID attribute	uidNumber	uidNumber	objectSid:S-1-5-xx-yy-zz (domain SID)
Group base DN	ou=groups, dc=example, dc=com	ou=groups, dc=example, dc=com	ou=groups, dc=example, dc=com
Group name attribute	gid	gid	sAMAccountName
GID attribute	gidNumber	gidNumber	objectSid:S-1-5-xx-yy-zz (domain SID)

#### 3.5.1.2 Testing connection to LDAP database

Refer to the section [Information>>>CLI>>>ldap-test](#) to get help on the CLI command.

To test connection to the LDAP database:

1. Connect to the CLI.
2. Launch `ldap-test --checkusername` command.
3. In case of error, use the `verbose` option of the command to investigate the reason.

### 3.5.1.3 Map remote users to profile



This step is mandatory and configures the Network module to give permissions to the LDAP users. Users not belonging to a group mapped on a profile will be rejected.

Configure the rules to mapped LDAP users to profile:

1. Enter LDAP group name.
2. Select the profile to assigned.

You can define up to 5 mapping rules.

All LDAP users belonging to the configured LDAP group will have permissions granted by the associated profile.



If a user belongs to multiple LDAP groups mapped to different profiles, the behavior is undefined.

### 3.5.1.4 Testing profile mapping

Refer to the section [Information>>>CLI>>>ldap-test](#) to get help on the CLI command.

To test LDAP users profile mapping:

1. Connect to the CLI.
2. Launch `ldap-test --checkmappedgroups` command.
3. This command will verify each mapped group exists in the LDAP base and will display the associated local profile.
4. In case of error, use the `verbose` option of the command to investigate the reason.

### 3.5.1.5 Define LDAP user's preferences

This step configures the user's preferences to apply to **all** LDAP users.

## 3.5.2 Testing LDAP authentication

Refer to the section [Information>>>CLI>>>ldap-test](#) to get help on the CLI command.

1. Connect to the CLI.
2. Launch `ldap-test --checkauth` command.
3. This command will verify an LDAP user can authenticate using his username and password and will display its local profile.
4. In case of error, use the `verbose` option of the command to investigate the reason

## 3.5.3 Limitations

- If the same username exists in both local and LDAP databases, the behavior is undefined.
- If a user belongs to multiple LDAP groups mapped to different profiles, the behavior is undefined.
- No client certificate provided. It is not possible for the server to verify the client authenticity.
- It is not possible to configure LDAP to work with 2 different search bases.
- LDAP user's preferences are common to **all** LDAP users.
- LDAP users cannot change their password through the Network Module.
- The remote groupname entered in profile mapping settings must be composed only of **alphanumerics**, underscore and hyphen characters (but this last one can't be at the beginning).

## 3.6 Pairing agent to the Network Module

Authentication and encryption of connections between the UPS network module and shutdown agents is based on matching certificates.

## 3.6.1 Pairing with credentials on the agent

**STEP 1:** Action on the agent (IPP or IPM).

1. Connect to the web interface of the agent.
2. Detect the UPS Network Module with an **Address(es) scan**, select **Override** global authentication settings and type the UPS Network Module credentials.

## 3.6.2 Pairing with automatic acceptance (recommended if done in a secure and trusted network)

Pairing with automatic acceptance of shutdown agents and UPS network modules is recommended in case the installation is done in a secure and trusted network, and when certificates cannot be created in other ways.

**STEP 1:** Action on the Network Module

1. Connect to the Network Module
  - On a network computer, launch a supported web browser. The browser window appears.
  - In the Address/Location field, enter: `https://xxx.xxx.xxx.xxx` where `xxx.xxx.xxx.xxx` is the static IP address of the Network Module.
  - The log in screen appears.
  - Enter the user name in the User Name field.
  - Enter the password in the Password field.
  - Click **Sign In**. The Network Module web interface appears.
2. Navigate to **Protection/Agents list** page
3. In the **Pairing with shutdown agents** section, select the time to accept new agents and press the **Start** button and the press **Continue**. During the selected timeframe, new agent connections to the Network Module are automatically trusted and accepted.

**STEP 2:** Action on the agent (IPP) while the time to accepts new agents is running on the Network Module:

- Connect to the web interface of the agent.
- Detect the UPS Network Module with a **Quick scan**, **Range scan** or an **Address(es) scan**.
- Right-click on the UPS Network Module when discovered and then **Set as power source**, **Configure** it, and **Save** it.

**STEP 3:** Action on the Network Module

1. Make sure all listed agents in the card (**Protection/Agents list**) belong to your infrastructure, if not, access may be revoked using the **Delete** button.
2. If the time for pairing still runs, you can stop it. Press **Stop** in the **Pairing with shutdown agents** section.



**STEP 1** and **STEP2** can be done either ways.

## 3.6.3 Pairing with manual acceptance

Manual pairing provides the maximum security.

**STEP 1:** Action on the agent (IPP)

1. Connect to the web interface of the agent
2. Detect the UPS Network Module with a **Quick scan**, **Range scan** or an **Address(es) scan**.
3. Define the power source

**Note:** After that stage, the agent creates a client certificate. The power source could show a communication loss since the current client certificate is not trusted by the Network Module.

4. Copy the agent certificate file **client.pem** that is located in the folder Eaton\IntelligentPowerProtector\configs\tls.**STEP 2:** Action on the Network Module

1. Connect to the Network Module

- On a network computer, launch a supported web browser. The browser window appears.
- In the Address/Location field, enter: `https://xxx.xxx.xxx.xxx` where `xxx.xxx.xxx.xxx` is the static IP address of the Network Module.
- The log in screen appears.
- Enter the user name in the User Name field.
- Enter the password in the Password field.
- Click **Sign In**. The Network Module web interface appears.

2. Navigate to **Settings/Certificate** page

3. In the **Trusted remote certificates** section, click **Import**, select **Protected applications (MQTT)** and then click on **CONTINUE**

4. Select the **client.pem** file previously saved, click **Open**. Communication with the agent is restored.

## 3.7 Powering down/up applications (examples)

### 3.7.1 Powering down IT system in a specific order

#### 3.7.1.1 Target

Powering down applications first (when on battery for 30s), database servers next (3min after the applications), and storage last (as late as possible).

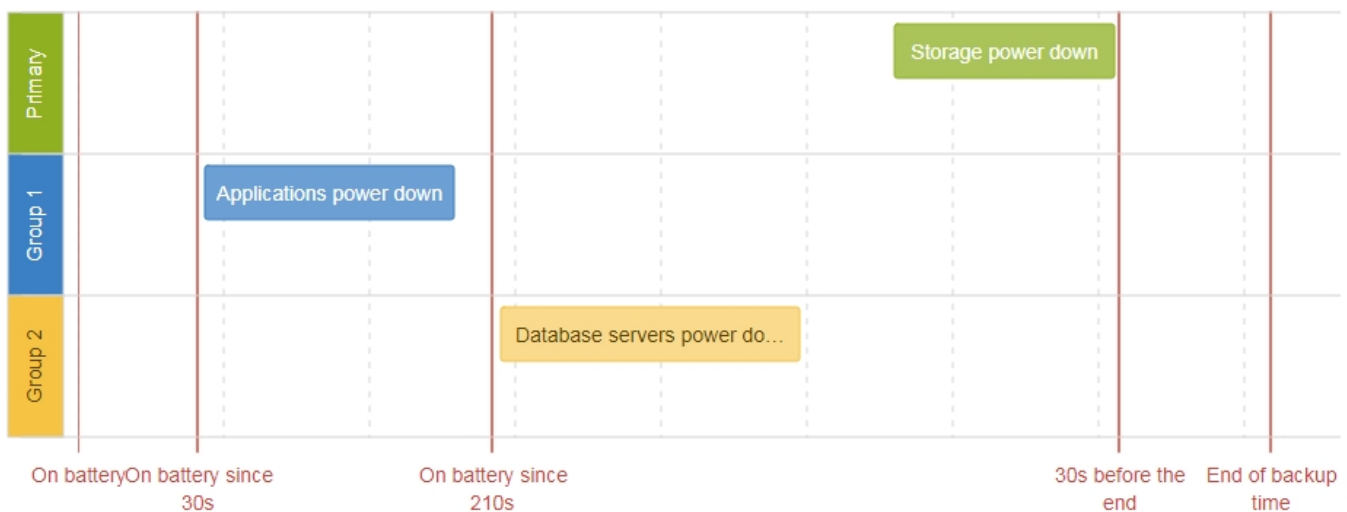

#### 3.7.1.2 Step 1: Installation setup

##### 3.7.1.2.1 Objective

Use load segmentation provided by the UPS to independently control the power supply of each IT equipment categories (Applications, Database servers, Storage).

It also allows IT equipment to sequentially restart on utility recovery ([Restart sequentially the IT equipment on utility recovery](#)).

##### 3.7.1.2.2 Resulting setup

UPS provides outlets (Group 1 and Group 2) and a primary output.



When primary shuts OFF, both group 1 and group 2 shut OFF immediately.

Connections to UPS are done as described below:

- Group 1: Applications
- Group 2: Database servers
- Primary: Storage

### 3.7.1.3 Step 2: Agent settings

#### 3.7.1.3.1 Objective

Ensure IT solution is shutdown gracefully.

#### 3.7.1.3.2 Resulting setup

1. Install IPP Software on each server (Application, Database servers, Storage) and register the UPS load segment as power source:

- Applications: Group 1
- Database servers: Group 2
- Storage: Entire UPS

2. Pair agent to the Network Module ([Pairing agent to the Network Module](#)).

When done, each server appears in the Agent list.

3. Navigate to **Protection/Agent settings** page.



For examples of Agent settings, see the [Agent settings examples](#) section.

4. Set the OS shutdown duration to the time needed for your server to shutdown gracefully.

This will make sure IPP shutdowns your servers before the load segment is powered down.

As a result, it will define the overall shutdown sequence duration for each load segments.

### 3.7.1.4 Step 3: Power outage policy settings

#### 3.7.1.4.1 Objective

Use load segment policies to define shutdown sequencing.

#### 3.7.1.4.2 Resulting setup

1. Navigate to **Protection/Power outage policy** page of the Network Module



For examples of Power outage policy, see the following sections:

- [Maximize availability policy example](#)
- [Immediate graceful shutdown policy example](#)
- [Load shedding policy examples](#)
- [Custom policy examples](#)

2. Enable policies of Primary, Group 1 and Group 2.

**Primary** with:

**Group 1** with:

**Group 2** with:

3. Set Primary to: **maximize availability policy**.

**Primary** with:

*by ending the shutdown sequence 30s before the end of backup time*

Storage is the last one to power down, its availability is maximized, and its shutdown will end 30s before the end of backup time.

4. Set Group 1 and Group 2 to: **load shedding policy**.

Applications must shutdown first so Group 1 has been set to start shutdown when on battery for 30s.

Servers must shutdown second, so Group 2 has been set to start shutdown when on battery for 210s, so 3min after the applications.

**Group 1** with:

*by starting the shutdown sequence*

when on battery for  s

OR

when the battery capacity is under  %

**Group 2** with:

*by starting the shutdown sequence*

when on battery for  s

OR

when the battery capacity is under  %

## 3.7.2 Powering down non-priority equipment first

### 3.7.2.1 Target

Powering down non-priority equipment first (immediately) and keep battery power for critical equipment.

Powering down critical equipment 3min before the end of backup time.

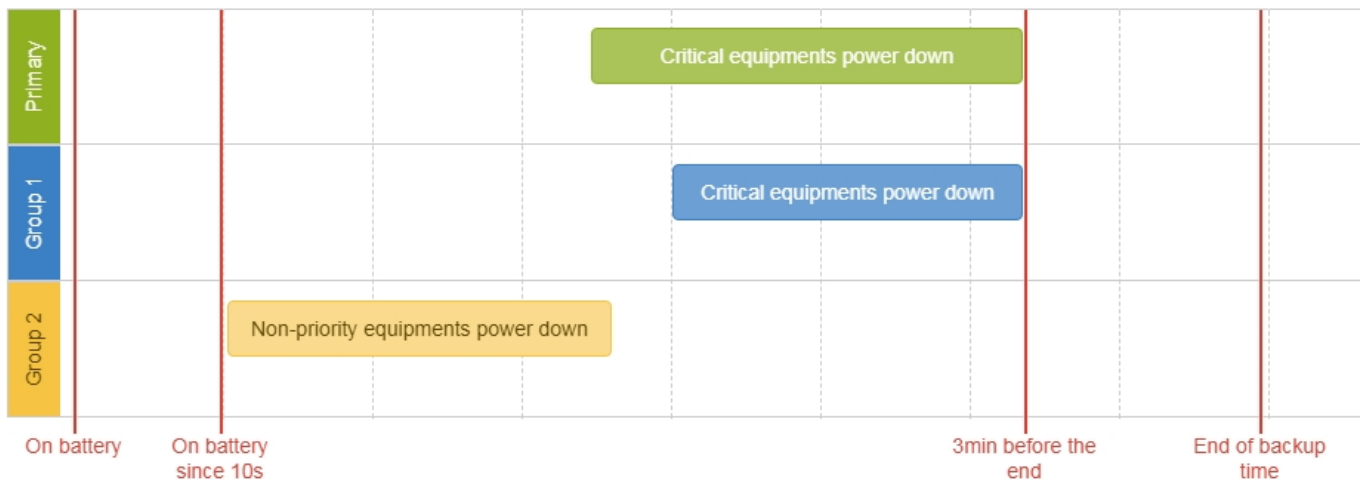

## 3.7.2.2 Step 1: Installation setup

### 3.7.2.2.1 Objective

Use load segmentation provided by the UPS to independently control the power supply of each IT equipment categories (Applications, Database servers, Storage).

Load segmentation also allows IT equipment to restart sequentially on utility recovery ([Restart sequentially the IT equipment on utility recovery](#)).

### 3.7.2.2.2 Resulting setup

UPS provides outlets (Group 1 and Group 2) and a primary output.



When primary shuts OFF, both group 1 and group 2 shut OFF immediately.

Connections can be done as described below:

- Group 2: non-priority equipment
- Group 1: critical equipment
- Primary: critical equipment

## 3.7.2.3 Step 2: Agent settings

### 3.7.2.3.1 Objective

Ensure IT solution is shutdown gracefully.

### 3.7.2.3.2 Resulting setup

1. Install IPP Software on each server (Application, Database servers, Storage) and register the UPS load segment as power source:

- Critical equipment: Group 1
- Non-priority equipment: Group 2
- Critical equipment: Entire UPS

2. Pair agent to the Network Module ([Pairing agent to the Network Module](#)).

When done, each server appears in the Agent list.

3. Navigate to **Protection/Agent settings** page



For examples of Agent settings, see the [Agent settings examples](#) sections.

4. Set the OS shutdown duration to the time needed for your server to shutdown gracefully.

This will make sure IPP shutdowns your servers before the load segment is powered down.

As a result, it will define the overall shutdown sequence duration for each load segments.

### 3.7.2.4 Step 3: Power outage policy settings

#### 3.7.2.4.1 Objective

Use load segment policies to define shutdown sequencing.

#### 3.7.2.4.2 Resulting setup

1. Navigate to **Protection/Power outage policy** page on the Network Module



For examples of Power outage policy, see the following sections:

- [Maximize availability policy example](#)
- [Immediate graceful shutdown policy example](#)
- [Load shedding policy examples](#)
- [Custom policy examples](#)

2. Enable policies of Primary, Group 1 and Group 2.

**Primary** with:

**Group 1** with:

**Group 2** with:

3. Set Primary and Group 1 to: **custom policy** and set it to end shutdown sequence 180s before the end of backup time.

**Primary** with: custom policy ▼

*by starting the shutdown sequence*

when on battery for 10 s

OR

when the battery capacity is under 0 %

OR

by ending ▼ the shutdown sequence 180 s before the end of the backup time



**Group 1 with:** custom policy ▼

*by starting the shutdown sequence*

when on battery for 10 s

OR

when the battery capacity is under 0 %

OR

by ending ▼ the shutdown sequence 180 s before the end of the backup time

Critical equipment is the last one to power down, their availability will be maximized and their shutdown will end 180s before the end of backup time.

4. Set Group 2 to: **immediate graceful shutdown policy**.

**Group 2 with:** immediate graceful shutdown policy ▼

*by starting the shutdown sequence after 10s*

Non-priority equipment immediately shuts down when on battery for 10s to keep battery power for critical equipment.

### 3.7.3 Restart sequentially the IT equipment on utility recovery

#### 3.7.3.1 Target

Restart the storage first (right after utility recovery), database servers next (2min after utility recovery) and applications last (3min after utility recovery).

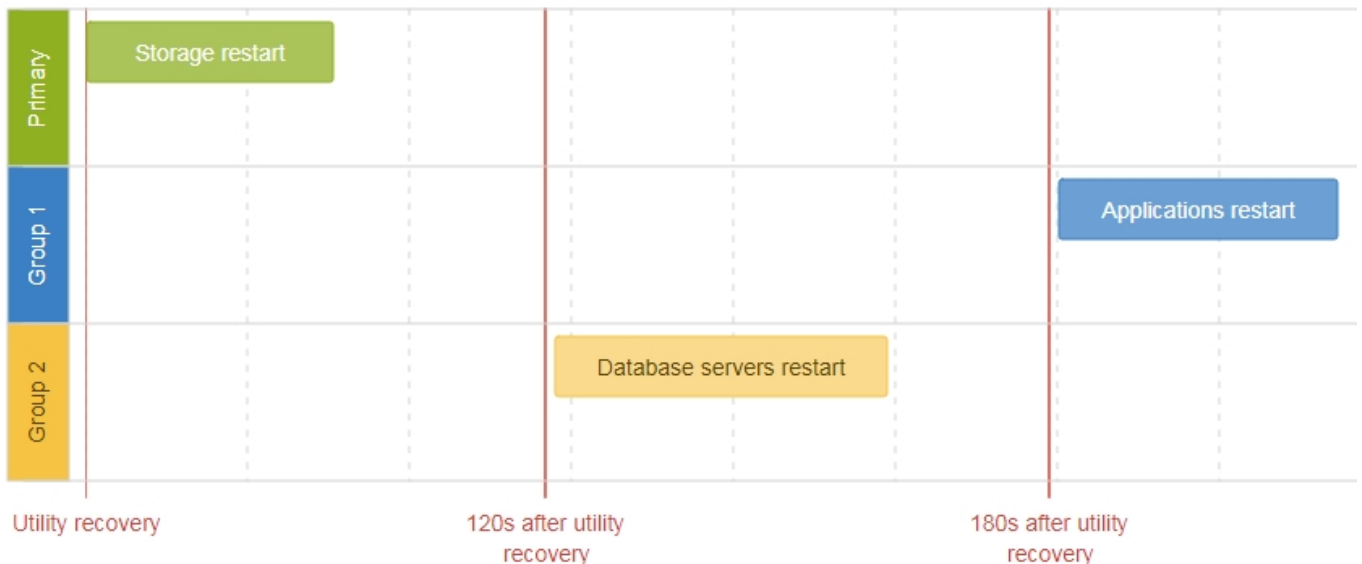

### 3.7.3.2 Step 1: Installation setup

#### 3.7.3.2.1 Objective

Use load segmentation provided by the UPS to independently control the power supply of each IT equipment categories (Applications, Database servers, Storage).

This will allow to restart sequentially the IT equipment on utility recovery.

#### 3.7.3.2.2 Resulting setup

UPS provides outlets (Group 1 and Group 2) and a primary output.



When utility recovers, primary starts immediately.

Connections to UPS can be done as described below:

- Group 1: Applications
- Group 2: Database servers
- Primary: Storage

### 3.7.3.3 Step 2: Power outage policy settings

#### 3.7.3.3.1 Objective

Use load segment restart settings to define restart sequencing.

#### 3.7.3.3.2 Resulting setup

1. Navigate to **Protection/Power outage policy** page and to the **When utility comes back** section.

**When utility comes back:**

- Keep shutdown sequence running until the end and then restart (forced reboot)
- Automatically restart the UPS when battery capacity exceeds  %
- Then Group 1 after**  s
- Then Group 2 after**  s

2. Enable the "Keep shutdown sequence running until the end and then restart (forced reboot)".

3. Enable the "Automatically restart the UPS when battery capacity exceeds" and set it to 0%.

The storage will restart first, right after utility recovery without waiting the battery capacity to exceed a % limit.

4. Set Then Group 1 after to 120s.

The database servers will restart 120s after the utility recovery.

5. Set Then Group 2 after to 60s.

The database servers will restart 180s after the utility recovery.

## 3.8 Checking the current firmware version of the Network Module

Current firmware of the Network Module can be accessed in :

- The footer: Version : x.xx.x
- The Card menu : [Card>>>System information>>>FW information](#): Firmware version x.xx.x
- The Card menu : [Card>>>Administration>>>Network module firmware](#): Active FW version x.xx.x

## 3.9 Accessing to the latest Network Module firmware/driver/script

Download the latest Eaton Network Module firmware, driver or script from the Eaton website [www.eaton.com/downloads](http://www.eaton.com/downloads).

## 3.10 Upgrading the card firmware (Web interface / shell script)



For instructions on accessing to the latest firmware and script, refer to: [Accessing to the latest firmware and script](#)

### 3.10.1 Web interface

To upgrade the Network module through the Web interface, refer to the section: [Firmware upgrade through the Web interface](#).

### 3.10.2 Shell script

#### 3.10.2.1 Prerequisite

Shell script uses the following tools: sshpass, scp.

To get it installed on your Linux host, use the following commands.

#### Debian/Ubuntu

```
$ sudo apt-get install sshpass scp
```

#### RedHat/Fedora/CentOS

```
$ sudo dnf install sshpass scp
```

Make shell script executable:

```
$ chmod 700 install_updatePackage.sh
```

#### 3.10.2.2 Procedure

To upgrade the Network module using:

1. Open a shell terminal on your computer (Linux or cygwin; meaning real or emulated Linux operating system).
2. Use the shell script `install_updatePackage.sh`

```
Usage: 'install_updatePackage.sh' [options]
Upgrade tool
Mandatory arguments are -f, -i, -u and -p
-h : show help
-f <path> : path of the upgrade file
-u <username> : username of a card user allowed to start upgrade
-p <password> : user password
-i <ipaddress> : ip address of the card to upgrade
-r : reboot the card after upgrade
```

### 3.10.3 Example:

```
$ ./install_updatePackage.sh -u admin -p <mypassword> -f FW_Update.tar -i <cardIpAddress> -r
```

```
STARTING UPDATE FROM: [FW_Update.tar] to [X.X.X.X]

Transfer by scp (FW_Update.tar) to [X.X.X.X]
Warning: Permanently added 'X.X.X.X' (ECDSA) to the list of known hosts.
Transfer done.
Check running upgrade status ...
Check firmware binary signature
Uncompress and flash upgrade - inProgress():11
Uncompress and flash upgrade - inProgress():28
Uncompress and flash upgrade - inProgress():44
Uncompress and flash upgrade - inProgress():61
Uncompress and flash upgrade - inProgress():78
Uncompress and flash upgrade - inProgress():92
Uncompress and flash upgrade - inProgress():100
Uncompress and flash upgrade - inProgress():100
Uncompress and flash upgrade
Executing post post_upgrade.sh script upgrade
Upgrade done
Warning: Permanently added 'X.X.X.X' (ECDSA) to the list of known hosts.
Rebooting...
res: Y
Update: OK
```

## 3.11 Changing the RTC battery cell

1. Access the Network Module, and then disconnect the Network cable, if needed.
2. Unscrew the Network Module and remove it from the slot.
3. Locate the RTC battery cell located on the back of the Network Module.

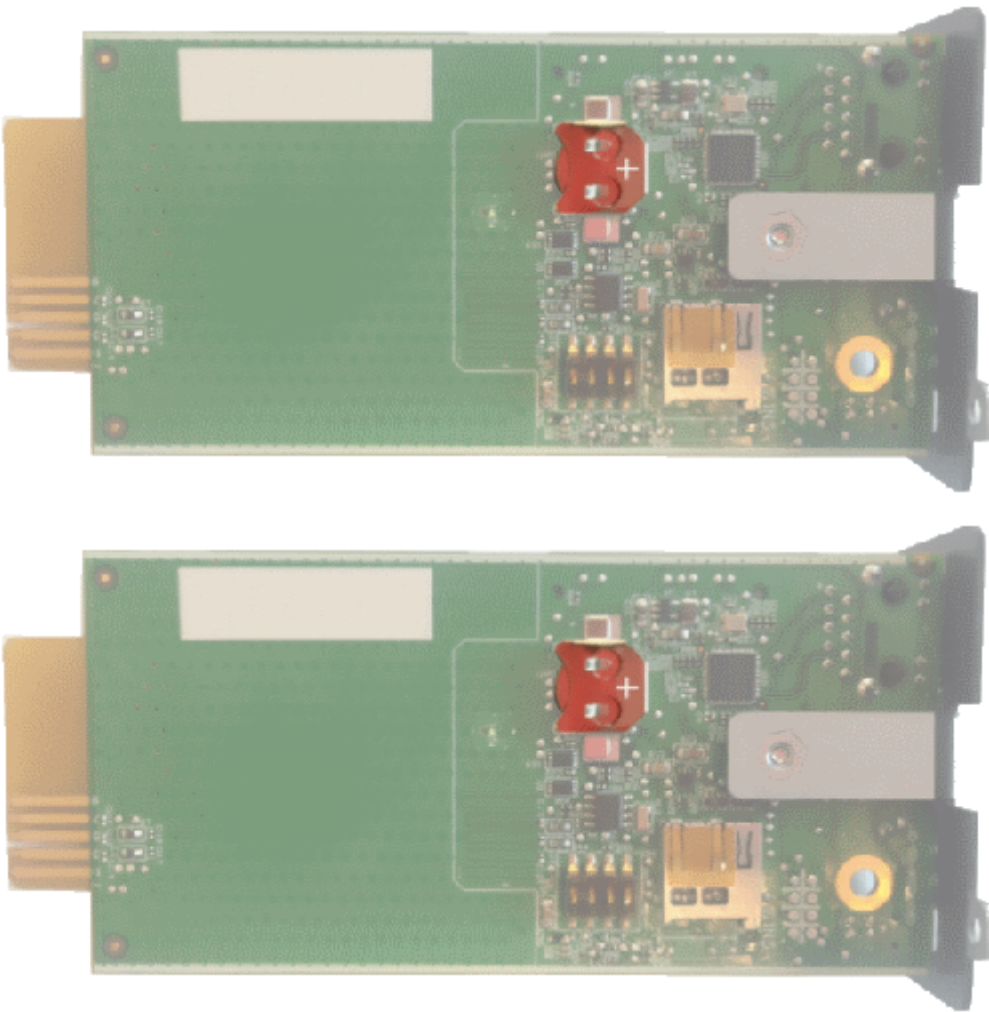

4. Get a new battery cell (CR1220 type).



5. Replace the battery cell, the positive mark (+) should be visible when inserting it.

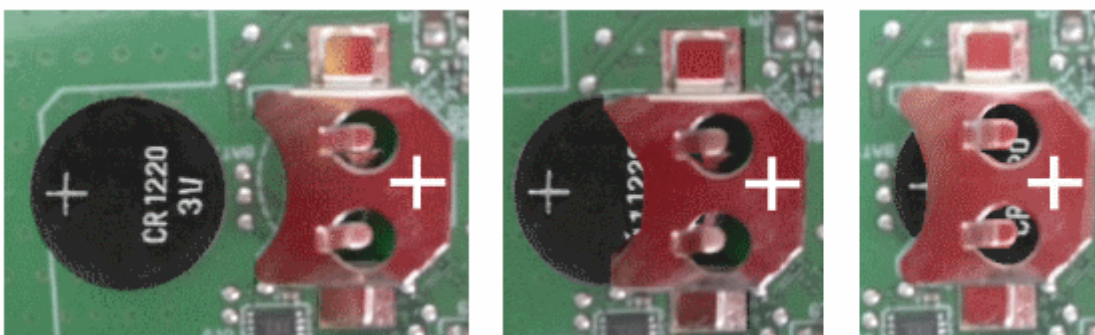

6. Replace the Network Module and secure the screw, reconnect the Network cable if it was unplugged during the operation.

7. Connect the Network Module and set the date and time. For more information, see the [Date & Time](#) section.

## 3.12 Updating the time of the Network Module precisely and permanently (ntp server)

For an accurate and quick update of the RTC for the Network Module, we recommend implementing a NTP server as time source for the Network Module.

LANs have an internal NTP server (Domain Controller, mail servers, Outlook servers are generally time servers too) but you can use a public ntp server like pool.ntp.org (after addition of the related rules to your firewall system).

For more information, see the [Date and Time](#) section.

## 3.13 Synchronizing the time of the Network Module and the UPS



This section is valid only when the UPS can manage date and time (refer to the UPS user manual for confirmation).



The Network Module use UTC time and manage the time zone and the DST.  
The UPS manage only the local time.

### 3.13.1 Automatic time synchronization

#### 3.13.1.1 Every day at 5 a.m.

The UPS time (local time) is synchronized with the Network Module.

#### 3.13.1.2 If the Network Module time is lost

The Network Module and the UPS time is synchronized with the oldest time between the last know Network Module time and the UPS time.

### 3.13.2 Manual time synchronization

#### 3.13.2.1 From the Network Module

On the Network Module, navigate to [Settings>>>Date & Time](#) section and update the time.

The UPS time (local time) is directly synchronized with the Network Module.

#### 3.13.2.2 From the UPS



When the time is updated on the UPS, it is not synchronized on the Network Module.

## 3.14 Changing the language of the web pages

Update the language of the web page in the Settings menu.

1. Navigate to [Settings>>>My preferences>>>Language](#).
2. Select the language, and then press the **Save** button.



The language of the login page is English by default or browser language when it is supported.

## 3.15 Resetting username and password

### 3.15.1 As an admin for other users

1. Navigate to [Settings>>>Users](#).
2. Press the pen icon  to edit user information.
3. Change username and save the changes.
4. Select Reset password and choose from the following options :
  - Generate randomly
  - Enter manually
  - Force password to be changed on next login
5. Enter your own password to confirm the changes.
6. Save the changes.

### 3.15.2 Resetting its own password

1. Navigate to [Settings>>>My preferences>>>Profile](#).
2. Press [Change password](#)
3. Enter your current password, the new password twice.
4. Press **Continue** to save the changes.

## 3.16 Recovering main administrator password

To recover the main administrator password, ask another administrator to initialize the password.

If it is not possible, proceed to the card sanitization:



**Below instruction will sanitize the card and blank all the data.**

Depending on your network configuration, the Network Module may restart with a different IP address. Only main administrator user will remain with default login and password. Refresh the browser after the Network module reboot time to get access to the login page.

1. Access the Network Module, disconnect the Network cable, if needed.
2. Unscrew the Network Module and remove it from the slot.
3. Locate the SANITIZATION switch that is located on the back of the Network Module.

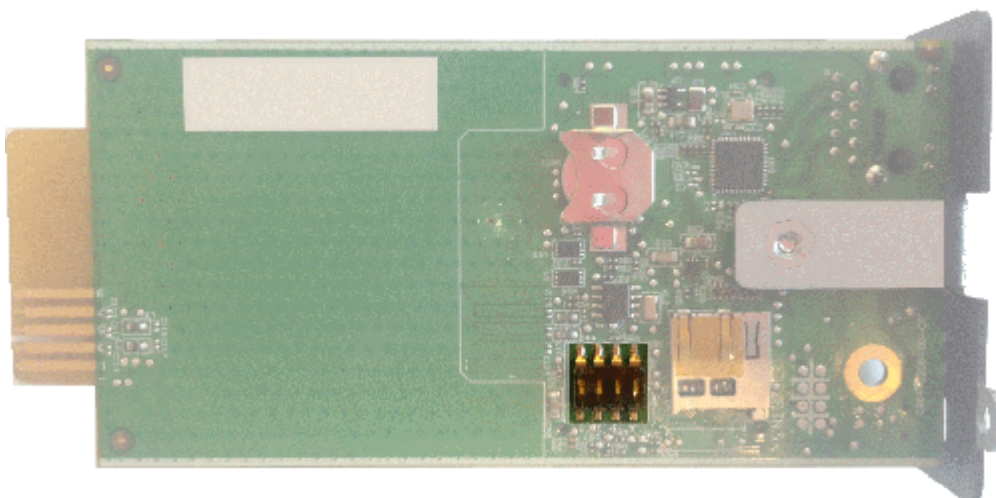

4. Peel off the protection :



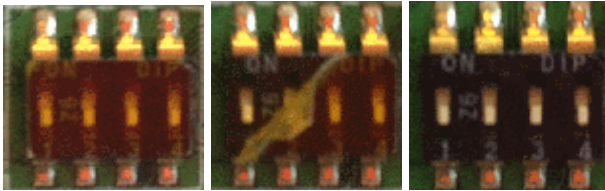

- Change the position of switch number 3, this change is detected during next power ON and the sanitization will be applied :

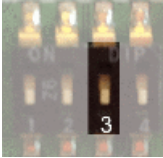
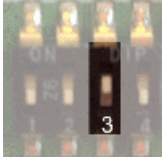
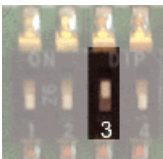
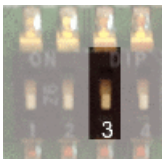
Case 1 :		
Case 2 :		



Changes of the switches 1, 2 or 4 has no effect.

- Replace the Network Module and secure the screw, connect the Network cable, if needed.
- Connect the Network Module by using the default credentials of the main administrator : admin/admin.
- You will be forced to change the password accordingly to the current password strength rules.

## 3.17 Switching to static IP (Manual) / Changing IP address of the Network Module

Administrators can switch to static IP in the Settings menu and change the IP address of the Network Module:

- Navigate to [Settings>>>Network>>>IPV4](#).
- Select Manual (Static IP).
- Input the following information:
  - IPv4 Address
  - Subnet Mask
  - Default Gateway
- Save** the changes.

## 3.18 Reading product (UPS) information in a simple way

### 3.18.1 Web page

The product information is located in the [Home page](#), specifically with the [Details button](#) on the top of the diagram and in the [Meters menu](#).



## 3.19 Subscribing to a set of alarms for email notification

### 3.19.1 Example #1: subscribing only to one alarm (load unprotected)

Follow the steps below:

1. Navigate to Settings>>>Email>>>Email sending configuration.
2. Press the button **New** to create a new configuration.
3. Select:
  - Active: Yes
  - Configuration name: Load unprotected notification
  - Email address: myaddress@mycompany.com
  - Notify on events: Active
  - Always notify events with code: 81E (Load unprotected)

## Add email sending configuration

Active Yes ▾

Configuration name Load unprotected notification

Email address myaddress@mycompany.com

 **Notify on events** *(Disabled)* ▾

---

Active Yes ▾



### On card events

Severity	Subscribe	Attach logs
Critical	<input type="checkbox"/>	<input type="checkbox"/>
Warning	<input type="checkbox"/>	<input type="checkbox"/>
Info	<input type="checkbox"/>	<input type="checkbox"/>

### On device events

Severity	Subscribe	Attach logs
Critical	<input type="checkbox"/>	<input type="checkbox"/>
Warning	<input type="checkbox"/>	<input type="checkbox"/>
Info	<input type="checkbox"/>	<input type="checkbox"/>

### Exceptions on events notification

 Always notify events with code 

81E



Logs will be attached by default in that example even if there is no subscription on card or device events.

4. Press **Save**, the table will show the new configuration.

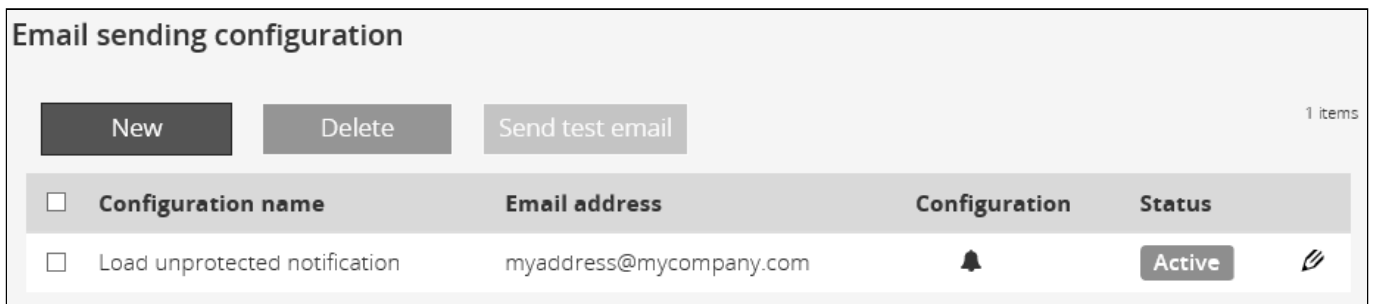

### 3.19.2 Example #2: subscribing to all Critical alarms and some specific Warnings

Follow the steps below:

1. Navigate to Settings>>>Email>>>Email sending configuration.
2. Press the button **New** to create a new configuration.
3. Select:
  - Active: Yes
  - Configuration name: ALL Critical and User account Warning notification
  - Email address: myaddress@mycompany.com
  - Notify on events: Active
  - Subscribe to Critical card events and Critical device events
  - Always notify events with code: 0800700, 0800900 (User account - password expired, User account- locked)

## Add email sending configuration

Active

Configuration name

Email address

Notify on events *(Disabled)*

Active

### On card events

Severity	Subscribe	Attach logs
Critical	<input checked="" type="checkbox"/>	<input checked="" type="checkbox"/>
Warning	<input type="checkbox"/>	<input type="checkbox"/>
Info	<input type="checkbox"/>	<input type="checkbox"/>

### On device events

Severity	Subscribe	Attach logs
Critical	<input checked="" type="checkbox"/>	<input checked="" type="checkbox"/>
Warning	<input type="checkbox"/>	<input type="checkbox"/>
Info	<input type="checkbox"/>	<input type="checkbox"/>

### Exceptions on events notification

Always notify events with code

4. Press **Save**, the table will show the new configuration.

Email sending configuration			
<input type="button" value="New"/>	<input type="button" value="Delete"/>	<input type="button" value="Send test email"/>	1 items
<input type="checkbox"/>	Configuration name	Email address	Configuration Status
<input type="checkbox"/>	ALL Critical and User account Warning notification	myaddress@mycompany.com	<input type="button" value="Active"/>

## 3.20 Saving/Restoring/Duplicating Network module configuration settings

### 3.20.1 Modifying the JSON configuration settings file

#### 3.20.1.1 JSON file structure

The JSON file is structured into 3 blocks:

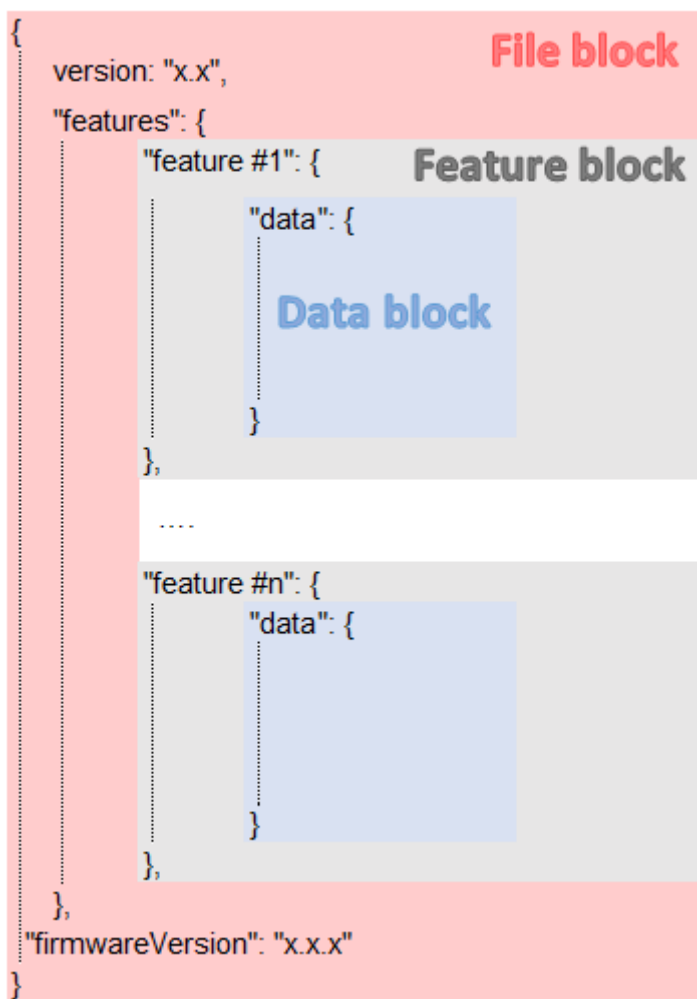

##### 3.20.1.1.1 File block

File block cannot be modified, this is the mandatory structure of the JSON file.

##### 3.20.1.1.2 Feature block

Feature block contains the full definition of a feature.

If it is removed from the JSON file, this feature settings will not be updated/restored in the card.

##### 3.20.1.1.3 Data block

Data block contains all the feature settings values.

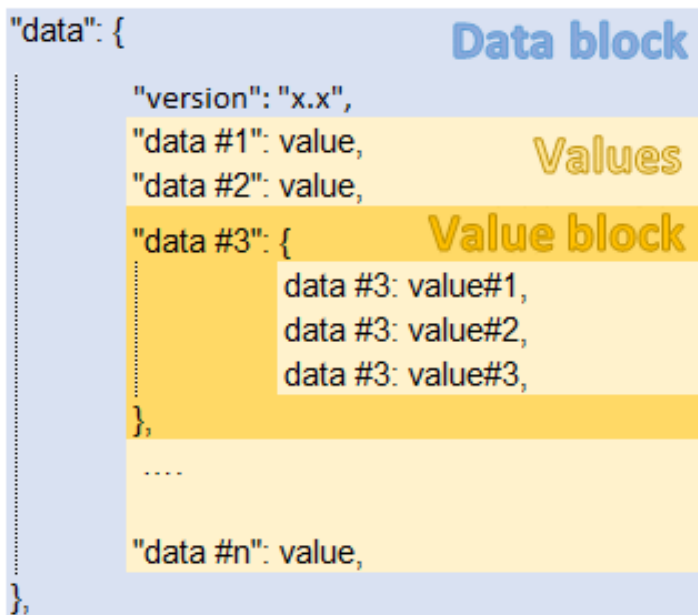

**a Data block**

Data block cannot be modified, this is the mandatory structure of the JSON file.

**b Value block**

If some values inside the Value block need to be kept, Value block structure cannot be modified, this is the mandatory structure of the JSON file.

If it is removed from the JSON file, these values will not be updated/restored.

**c Values**

Values can be kept as is, modified or removed.

Removed values will not be updated/restored.

### 3.20.1.2 Sensitive data (like passwords)

JSON file structure will slightly varies if sensitive data are exported with passphrase or not.

#### 3.20.1.2.1 The JSON file is saved using passphrase (preferred)

All sensitive data will have below structure:

```
"password": {
  plaintext: "null",
  cyphered: "p-twlcjoV-a8FjMjkagL6w"
},
```



When restoring the file, the corresponding setting will be updated based on the cyphered value.

#### 3.20.1.2.2 The JSON file is saved without passphrase

All sensitive data will have below structure:

```
"password": {
  plaintext: "null",
},
```



When restoring the file, the corresponding setting will not be set. This may lead to restoration failure if corresponding setting was not previously set with a valid value.

### 3.20.1.3 Modifying JSON file examples

#### 3.20.1.3.1 Modifying sensitive data

To change sensitive data, plain text must be filled with the new value **and the Cyphered entry (if existing) must be removed:**

```
"password": {
  plaintext: "New password",
},
```

#### 3.20.1.3.2 Adding local users

Adding or modifying local users is not yet available, only the predefined account (main administrator) can be modified.

#### 3.20.1.3.3 Modifying SNMP settings

Original file:	Modified file:
SNMP disabled	SNMP enabled on port 161 SNMPv1 disabled SNMPv3 enabled 2 x accounts 1 x read only user (enabled) with Auth-Priv security level and passwords 1x read write user (enabled) with Auth-Priv security level and passwords 1 x active trap

Original file:	Modified file:
<pre> snmp: {   data: {     version: "x.x",     dmeData: {       enabled: false,       port: xxxx,       v1: {         enabled: false,         communities: {           .....         }       },       v3: {         enabled: false,         users: [           .....         ]       },       traps: {         receivers: [           ]         }       }     }   } } </pre>	<pre> snmp: {   data: {     version: "x.x",     dmeData: {       enabled: true,       port: 161,       v1: {         enabled: false,         communities: {           .....         }       },       v3: {         enabled: true,         users: [           {             name: "readonly",             allowWrite: false,             enabled: true,             auth: {               enabled: true,               password: {                 plaintext: xxxxxxxxxxxxxx               }             },             priv: {               enabled: true,               password: {                 plaintext: yyyyyyyyyyyyyyy               }             }           },           {             name: "readwrite",             allowWrite: true,             enabled: true,             auth: {               enabled: true,               password: {                 plaintext: zzzzzzzzzzzzzzzzzzz               }             },             priv: {               enabled: true,               password: {                 plaintext: wwwwwwwwww               }             }           }         ]       },       traps: {         receivers: [           {             name: "xxxxxxx",             host: "xxx.xx.xxx.xx",             port: xxx,             community: "xxxxx",             protocol: x,             user: "",             enabled: xxxx           }         ]       }     }   } } </pre>

### 3.20.1.3.4 Making a partial update/restoration

#### a Example: Updating/Restoring only LDAP settings

If you restore below JSON content, only LDAP settings will be updated/restored, everything else will remain unchanged.



```

{
  "version": "x.x",
  "features": {
    "ldap": {
      "data": {
        "version": "x.x",
        "certificateData": [],
        "dmeData": {
          "enabled": true,
          "baseAccess": {
            "security": {"ssl": 1, "verifyTlsCert": false},
            "primary": {"name": "Primary", "hostname": "xxxxxxxx"},
            "secondary": {"name": "xxxxxx", "hostname": "xxxxxx"},
            "credentials": {
              "anonymousSearchBind": false,
              "searchUserDN":
                "CN=xxxx,OU=xxxx,OU=xxxx,OU=xxxx,DC=xxxx,DC=xxxx",
              "password": {"plaintext": null}},
              "searchBase": {"searchBaseDN": "DC=xxx,DC=xxx,DC=xxx"}
            }
          }
        },
        "requestParameters": {
          "userBaseDN": "OU=xxxx,DC=xxxx",
          "userNameAttribute": "xxxx",
          "uidAttribute": "objectSid:x-x-x-xx-xxxxxxxxxx-
xxxxxxxxxxxx-xxxxxxxxxxxx",
          "groupBaseDN": "OU=xxxx,DC=xxxx",
          "groupNameAttribute": "xx",
          "gidAttribute": "objectSid:x-x-x-xx-xxxxxxxxxx-
xxxxxxxxxxxx-xxxxxxxxxxxx"
        },
        "profileMapping": [
          { "remoteGroup": "xxxxxxxxxxxx", "profile": 1},
          { "remoteGroup": "xxxxxxxxxxxx", "profile": 2},
          { "remoteGroup": "", "profile": 0},
          { "remoteGroup": "", "profile": 0},
          { "remoteGroup": "", "profile": 0}
        ]
      }
    }
  },
  "firmwareVersion": "x.x.x"
}

```

### 3.20.1.4 Non-intuitive data values in the JSON file

	Data	Values example
--	------	----------------

<b>Account service</b>	preferences>>>language	de: Deutsh en: English es: Español fr: Français it: Italiano ja: 日本語 zh_Hans: 简体中文 zh_Hant: 繁體中文
	preferences>>>dateFormat	Y-m-d: YYYY-MM-DD d-m-Y: DD-MM-YYYY d.m.Y: DD.MM.YYYY d/m/Y: DD/MM/YYYY m/d/Y: MM/DD/YYYY d m Y: DD MM YYYY
	preferences>>>timeFormat	1: 24h 0: 12h
	preferences>>>temperatureUnit	1: °C 2: °F

	Data	Values example
<b>Card</b>	-	-

	Data	Values example
<b>Date</b>	timeZone	"Europe/Paris","Africa/Johannesburg","America/New_York","Asia/Shanghai"  <i>Refer to the Web interface for the full list.</i>

	Data	Values example
<b>email</b>	periodicReport>>>periodicity	Every day Every week Every month
	periodicReport>>>startTime	timestamp (unix)

	Data	Values example
<b>LDAP</b>	baseAccess>>>security>>>ssl	1: None 2: Start TLS 3: SSL
	baseAccess>>>profileMapping>>>profile	administrators viewers operators

	Data	Values example
<b>Measure</b>	-	-

	Data	Values example
--	------	----------------

MQTT	-	-
	<b>Data</b>	<b>Values example</b>
Power outage policy	id	1: Primary 2: Group 1 3: Group 2
	<b>Data</b>	<b>Values example</b>
Remote user	preferences>>>language	de: Deutsh en: English es: Español fr: Français it: Italiano ja: 日本語 zh_Hans: 简体中文 zh_Hant: 繁體中文
	preferences>>>dateFormat	Y-m-d: YYYY-MM-DD d-m-Y: DD-MM-YYYY d.m.Y: DD.MM.YYYY d/m/Y: DD/MM/YYYY m/d/Y: MM/DD/YYYY d m Y: DD MM YYYY
	preferences>>>timeFormat	1: 24h 0: 12h
	preferences>>>temperatureUnit	1: °C 2: °F
	<b>Data</b>	<b>Values example</b>
Schedule	scheduler	1: Primary 2: Group 1 3: Group 2
	recurrence	0: once 1: every day 2: every week
	shutdownTimeStamp	timestamp (unix)
	restartTimeStamp	timestamp (unix)
	<b>Data</b>	<b>Values example</b>
SMTP	-	-
	<b>Data</b>	<b>Values example</b>
SNMP	traps>>>receivers>>>protocol	1: SNMP v1 3: SNMP v2

	traps>>>receivers>>>user	User configuration cannot be duplicated without manual configuration through the Web interface.
	<b>Data</b>	<b>Values example</b>
<b>Syslog</b>	servers>>>protocol	1: UDP 2: TCP
	servers>>>tcpframing	1: TRADITIONAL 2: OCTET_COUNTING
	<b>Data</b>	<b>Values example</b>
<b>Web server</b>	-	-

### 3.20.2 Saving/Restoring/Duplicating settings through the CLI

Navigate to [Information>>>CLI>>>save\\_configuration | restore\\_configuration](#) section to get example on how to save and restore settings through the CLI.

### 3.20.3 Saving/Restoring/Duplicating settings through the Web interface

Navigate to [Card>>>Administration](#) section to get information on how to save and restore settings through the Web interface.

## 4 Securing the Network Management Module

### 4.1 Cybersecurity considerations for electrical distribution systems

#### 4.1.1 Purpose

The purpose of this section is to provide high-level guidance to help customers across industries and applications apply Eaton solutions for power management of electrical systems in accordance with current cybersecurity standards.

This document is intended to provide an overview of key security features and practices to consider in order to meet industry recommended standards and best practices.

#### 4.1.2 Introduction

Every day, cyber-attacks against government and commercial computer networks number in the millions. According to U.S. Cyber Command, Pentagon systems are probed 250,000 times per hour. Similar attacks are becoming more prevalent on other kinds of information-based smart networks as well, such as those that operate buildings and utility systems. Whether the objective is to steal intellectual property or halt operations, the tools and the techniques used for unauthorized network access are increasingly sophisticated.

#### 4.1.3 Connectivity—why do we need to address cybersecurity for industrial control systems (ICS)?

There is increasing concern regarding cybersecurity across industries where companies are steadily integrating field devices into enterprise-wide information systems. This occurs in discrete manufacturing and process industrial environments, a wide range of general and specific purpose commercial buildings, and even utility networks. Traditionally, electrical systems were controlled through serial devices connected to computers via dedicated transceivers with proprietary protocols. In contrast, today's control systems are increasingly connected to larger enterprise networks, which can expose these systems to similar vulnerabilities that are typically found in computer systems. The differences between information technology (IT) and ICS networks can be summarized as follows:

- The main focus of the IT network is to ensure the **confidentiality** and the **integrity** of the data using rigorous access control and data encryption
- The main focus of the ICS network is **safety, availability, and integrity** of data
- Enterprise security protects the servers' data from attack
- Control system security protects the facility's ability to safely and securely operate, regardless of what may befall the rest of the network

#### 4.1.4 Cybersecurity threat vectors

Cybersecurity threat vectors are paths or tools that an entity can use to gain access to a device or a control network in order to deliver a malicious attack. Figure below shows examples of attack vectors on a network that might otherwise seem secure.

#### 4.1.4.1 Paths to the control network

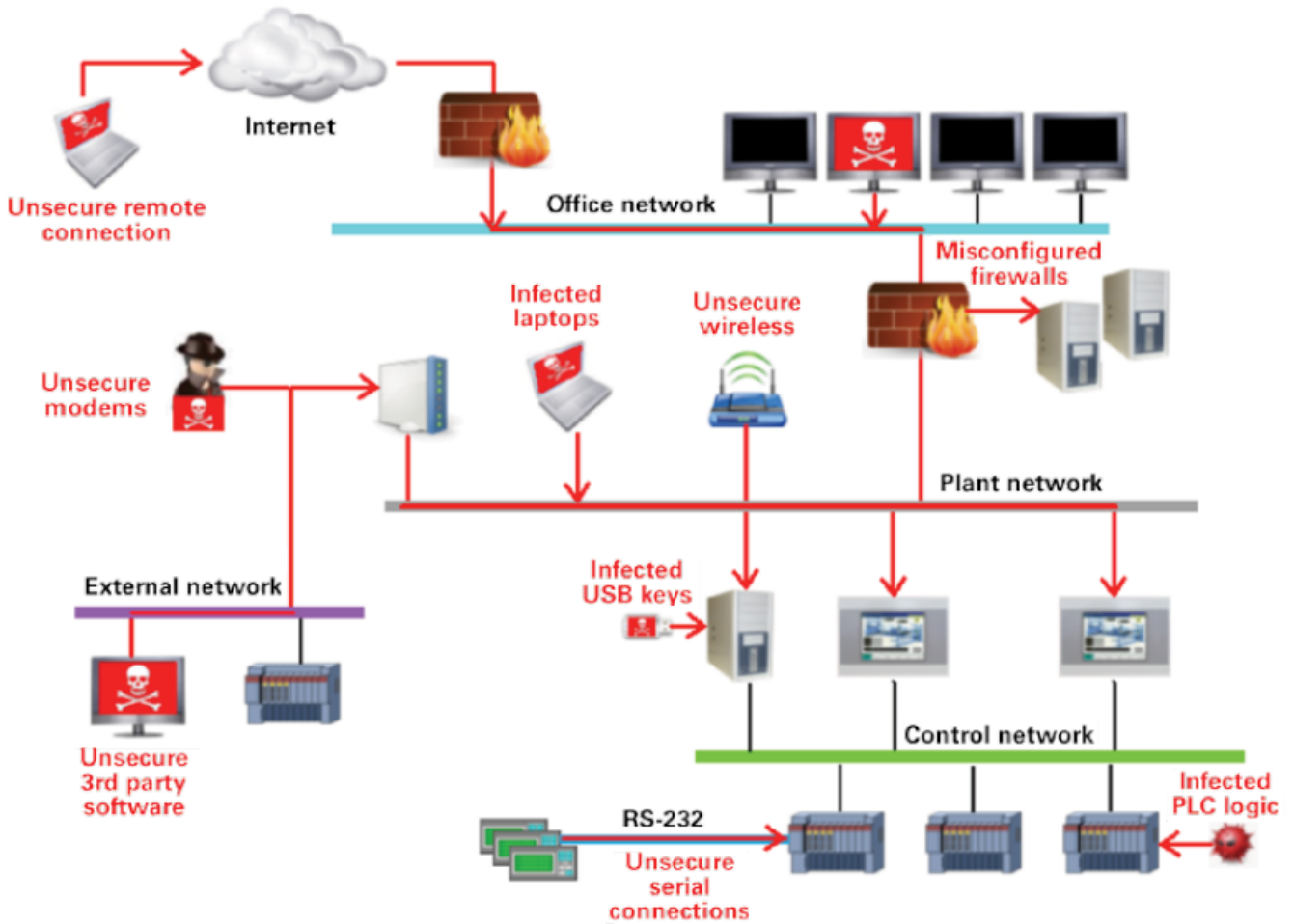

The paths in above figure include:

- External users accessing the network through the Internet
- Misconfigured firewalls
- Unsecure wireless routers and wired modems
- Infected laptops located elsewhere that can access the network behind the firewall
- Infected USB keys and PLC logic programs
- Unsecure RS-232 serial links

The most common malicious attacks come in the following forms:

- Virus—a software program that spreads from one device to another, affecting operation
- Trojan horse—a malicious device program that hides inside other programs and provides access to that device
- Worm—a device program that spreads without user interaction and affects the stability and performance of the ICS network
- Spyware—a device program that changes the configuration of a device

#### 4.1.5 Defense in depth

While there are differences between traditional IT systems and ICS, the fundamental concept of “defense in depth” is applicable to both. Defense in depth is a strategy of integrating technology, people, and operations capabilities to establish variable barriers across multiple layers of an organization. These barriers include electronic countermeasures such as firewalls, intrusion detection software/components, and antivirus software, coupled with physical protection policies and training. Fundamentally, the barriers are intended to reduce the probability of attacks on the network and provide mechanisms to detect “intruders.”

## 4.1.6 Designing for the threat vectors

### 4.1.6.1 Firewalls

Firewalls provide the capability to add stringent and multifaceted rules for communication between various network segments and zones in an ICS network. They can be configured to block data from certain segments, while allowing the relevant and necessary data through. A thorough understanding of the devices, applications, and services that are in a network will guide the appropriate deployment and configuration of firewalls in a network. Typical types of firewalls that can be deployed in a network include:

- **Packet filter or boundary firewalls that work on the network layer**  
These firewalls mainly operate at the network layer, using pre-established rules based on port numbers and protocols to analyze the packets going into or out of a separated network.  
These firewalls either permit or deny passage based on these rules.
- **Host firewalls**  
These firewalls are software firewall solutions that protect ports and services on devices. Host firewalls can apply rules that track, allow, or deny incoming and outgoing traffic on the device and are mainly found on mobile devices, laptops, and desktops that can be easily connected to an ICS.
- **Application-level proxy firewalls**  
These firewalls are highly secure firewall protection methods that hide and protect individual devices and computers in a control network. These firewalls communicate at the application layer and can provide better inspection capabilities. Because they collect extensive log data, application-level proxy firewalls can negatively impact the performance of an ICS network.
- **Stateful inspection firewalls**  
These firewalls work at the network, session, and application layers of the open system interconnection (OSI). Stateful inspection firewalls are more secure than packet filter firewalls because they only allow packets belonging to allowed sessions.  
These firewalls can authenticate users when a session is established and analyze a packet to determine whether they contain the expected payload type or enforce constraints at the application layer.
- **SCADA hardware firewalls**  
These are hardware-based firewalls that provide defense for an ICS based on observing abnormal behavior on a device within the control network. For example, if an operator station computer suddenly attempts to program a PLC, this activity could be blocked and an alarm could be raised to prevent serious risk to the system.

### 4.1.6.2 Demilitarized zones (DMZ)

Network segmentation is a key consideration in establishing secure control networks. Firewalls should be used to create DMZ by grouping critical components and isolating them from the traditional business IT network. A three-tier architecture should be employed at a minimum, with a DMZ between the organization's core network and an isolated control system's network as shown in below figure.

#### 4.1.6.2.1 Three-tier architecture for a secure control network

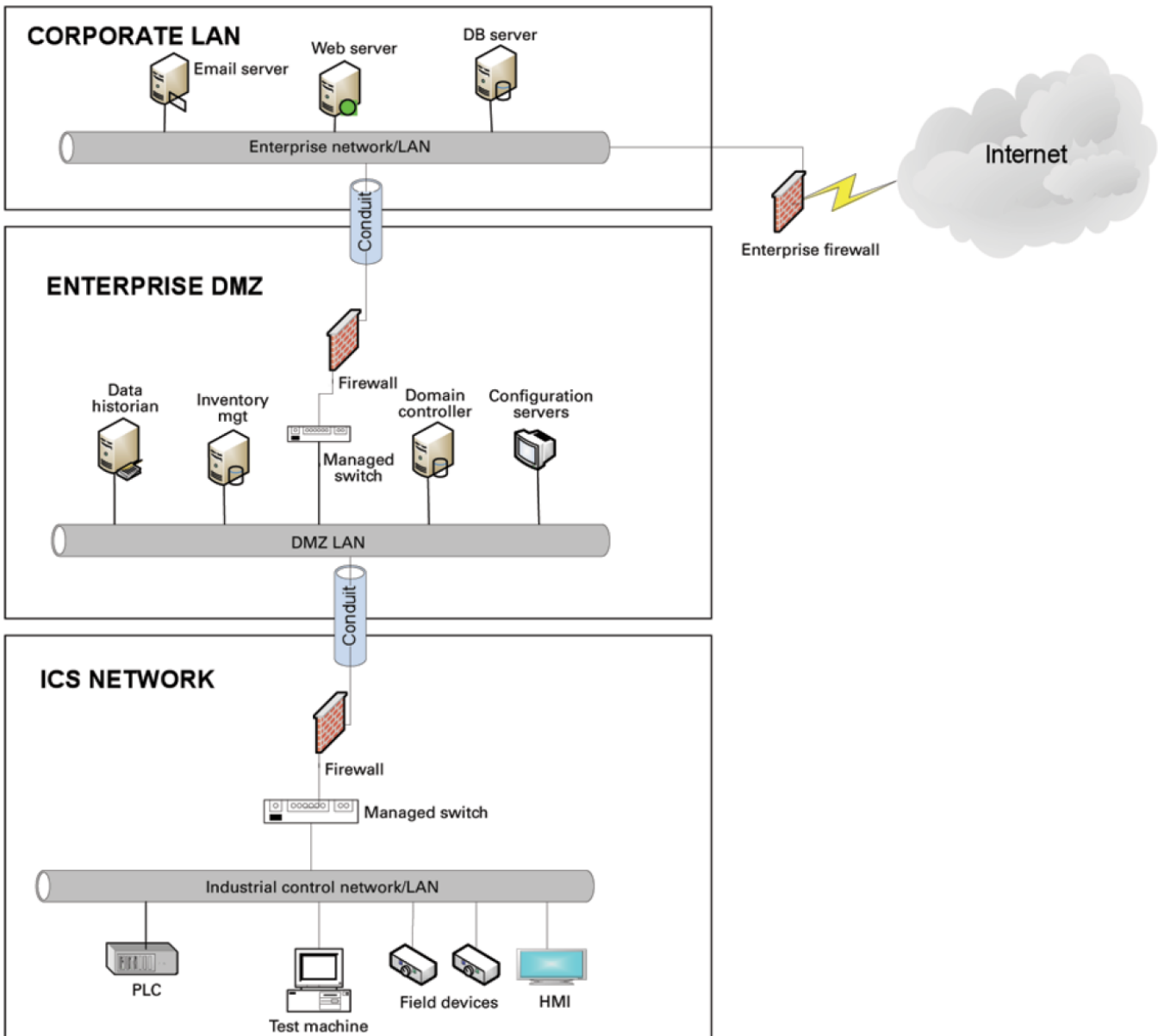

Above figure shows that the control networks are divided into layers or zones based on control functions, which are then connected by conduits (connections between the zones) that provide security controls to:

- Control access to zones
- Resist denial of services (DOS) attacks or the transfer of malware
- Shield other network systems
- Protect the integrity and the confidentiality of network traffic

Beyond network segmentation, access control (both physical and logical) should be defined and implemented.

The key consideration when designing access control is defining the **required** interactions both within a given zone and between zones. These interactions should be mapped out clearly and prioritized based on need. It is important to realize that every hole poked in a firewall and each non-essential functionality that provides access or creates additional connectivity increases potential exposure to attacks. A system then becomes only as secure as the devices connecting to it.

If mapped correctly, the potential adverse impact to control system reliability and functionality should be negligible. However, this element introduces additional costs (in terms of firewall and other network infrastructure) and complexity to the environment.



### 4.1.6.3 Intrusion detection and prevention systems (IDPS)

These are systems that are primarily focused on identifying possible incidents in an ICS network, logging the information about them, attempting to stop them, and reporting them to ICS security administrators.

Because these systems are critical in an ICS network, they are regular targets for attacks and securing them is extremely important.

The type of IDPS technology deployed will vary with the type of events that need to be monitored.

There are four classes of IDPS technology:

- Network-based IDPS monitors network traffic for particular ICS network segments or devices and analyzes the network and application protocol activity to identify suspicious activity
- Wireless IDPS monitors and analyzes wireless network traffic to identify suspicious activity involving the ICS wireless network protocol
- Network behavior analysis IDPS examines ICS network traffic to identify threats that generate unusual traffic flows such as DOS attacks
- Host-based IDPS monitors the characteristics and the events occurring within a single ICS network host for suspicious activity

### 4.1.7 Policies, procedures, standards, and guidelines

For the defense in depth strategy to succeed, there must be well-documented and continuously reviewed policies, procedures, standards, and guidelines.

- **Policies** provide procedures or actions that must be carried out to meet objectives and to address the who, what, and why
- **Procedures** provide detailed steps to follow for operations and to address the how, where, and when
- **Standards** typically refer to specific hardware and software, and specify uniform use and implementation of specific technologies or parameters
- **Guidelines** provide recommendations on a method to implement the policies, procedures, and standards

#### 4.1.7.1 Understanding an ICS network

Creating an inventory of all the devices, applications, and services that are hosted in a network can establish an initial baseline for what to monitor. Once those components are identified and understood, control, ownership, and operational consideration can be developed.

#### 4.1.7.2 Log and event management

It is important to understand what is happening within the network from both a performance and security perspective. This is especially true in a control systems environment.

Log and event management entails monitoring infrastructure components such as routers, firewalls, and IDS/IPS, as well as host assets. Security Information and Event Management (SIEM) systems can collect events from various sources and provide correlation and alerts.

Generating and collecting events, or even implementing a SIEM is not sufficient by itself. Many organizations have SIEM solutions, but alerts go unwatched or unnoticed.

Monitoring includes both the capability to monitor environments and the capacity to perform the monitoring. Capability relates to the

design and the architecture of the environment. Has it been built in a manner that takes into consideration the ability to monitor? Capacity speaks to the resources (personnel, tools, expertise) needed to perform meaningful interpretation of the information and initiate timely and appropriate action.

Through monitoring, the organization can identify issues such as suspicious or malicious activities. Awareness can be raised when new (potentially unauthorized) devices appear in the environment. Careful consideration should be taken into account to ensure that log and event management does not adversely impact the functionality or the reliability of the control system devices.

### 4.1.7.3 Security policy and procedures

It is important to identify “asset owners,” and to develop policies and procedures for a cybersecurity program. These policies need to be practical and enforceable in order to be effective. Policies should also address access related issues, such as physical access, contractors, and vendors.

Existing (traditional) IT standards and policies may not apply (or have not been considered) for control systems. A gap analysis should be performed to determine which components are not covered (or not adequately covered) by existing policies. Relationships with existing policies and standards should be explicitly identified and new or supporting policies should be developed. It is important that industrial control system administrators have proper authorizations and full support of their management to implement policies that will help secure the ICS network.

### 4.1.7.4 ICS hardening

The goal for system hardening is to reduce as many security risks as possible by securely configuring ICS networks. The idea is to establish configurations based on what is required and eliminate unnecessary services and applications that could potentially provide another possible entry point to an intruder.

Minimum security baselines should be established for the various platforms and products deployed (operating system, application, and infrastructure elements such as drives, meters, HMI devices). The following actions should be implemented where applicable:

- Disable unnecessary services
- Disable anonymous FTP
- Do not use clear text protocols (e.g., use SSH v2 instead of Telnet)
- Install only required packages/applications/features
- Deploy antivirus solutions (where possible)
- Disable or otherwise control use of USB devices
- Establish a warning banner
- Change default passwords (e.g., SNMP)

It may be easier to implement these actions on devices for which you control the base operating system platform. However, several of the items listed above can be configured from the product specific configuration options.

Changes such as these could potentially impact the functionality of a control system device. Extensive testing needs to be conducted before deployment to minimize this impact.

### 4.1.7.5 Continuous assessment and security training

It is critical that ICS network administrators and regular users be properly trained to ensure the security of the ICS and the safety of the people who operate and depend on it.

Ongoing vulnerability assessments are critical to identify issues and understand the effectiveness of other defensible network elements.

Assessments should include testing and validating the following:

- Monitoring capabilities and alerts are triggered and responded to as expected
- Device configuration of services and applications
- Expected connectivity within and between zones
- Existence of previously unknown vulnerabilities in the environment
- Effectiveness of patching

A program should be established for performing assessments.

The actual assessment should be performed by a qualified resource, which can be an in-house or third-party organization. Regardless of who performs the assessments, in-house resources need to be involved in the planning, scoping, and supporting of assessment activities and must be appropriately trained to do so.

Assessments should be conducted according to a methodology that is clearly defined to address:

- Physical security
- People and processes
- Network security
- Host security
- Applications security (both internally developed and commercially off-the-shelf (COTS))

### 4.1.7.6 Patch management planning and procedures

A patching and vulnerability management process should be established based on the timely awareness of issues and appropriate action. This process should take all of the elements that make up the control system environment into consideration.

Information resources should be identified for vulnerability and advisory information for the various components in the environment. These should include vendor-specific sources as well as other public or commercial services that provide vulnerability advisory information. For example, the National Vulnerability Database (NVD) provides information related to vulnerabilities identified in general IT components, while the Industrial Control Systems Cyber Emergency Response Team (ICS-CERT) publishes advisories specific to control systems.

A regular patch deployment schedule should be established for each component in the environment. Depending on the component, this could range from a monthly schedule to an as-needed deployment, depending on the historical frequency of patch or vulnerability related issues for the component or the vendor. Additionally, out-of-band or emergency patch management needs to be considered and qualifications need to be defined.

Vulnerability information and advisories should be reviewed regularly and assessments should be performed to determine the relative severity and urgency of issues.

Elements of the process should also include the preparation, scheduling, and change controls; testing and rollback procedures; and pre-deployment notification to stakeholders that includes scope, expectations, and reporting. Testing is a significant element, as the effect of the patch application needs to be clearly understood; unintended or unexpected impacts to a control system component influence the decision to deploy a patch. In the event that it is determined that a patch cannot be safely deployed but the severity of the issue represents a significant concern, compensating controls should be investigated.

### 4.1.8 Conclusion

To protect important assets, all organizations must take cybersecurity threats seriously and meet them proactively with a system-wide defensive approach specific to organizational needs.

There is no protection method that is completely secure. A defense mechanism that is effective today may not be effective tomorrow– the ways and means of cyber-attacks constantly change. It is critical ICS administrators remain aware of changes in cybersecurity and continue to work to prevent any potential vulnerabilities in the systems they manage.

### 4.1.9 Terms and definitions

<b>DMZ</b>	A demilitarized zone is a logical or physical sub network that interfaces an organization’s external services to a larger, untrusted network and providing an additional layer of security.
<b>Encryption</b>	The process of transforming plain or clear text using an algorithm to make it unreadable to anyone except those possessing special knowledge.
<b>ICS</b>	A device or set of device that manage, command, direct, or regulate the behavior of other devices or systems.
<b>Protocol</b>	A set of standard rules for data representation, signaling, authentication, and error detection required to send information over a communications channel

### 4.1.10 Acronyms

<b>COTS</b>	Commercially Off-the-Shelf
<b>DMZ</b>	Demilitarized Zone
<b>DOS</b>	Denial of Service
<b>FTP</b>	File Transfer Protocol
<b>HMI</b>	Human Machine Interface
<b>ICS</b>	Industrial Control Systems
<b>ICS-CERT</b>	Industrial Control Systems - Cyber Emergency Response Team
<b>IDPS</b>	Intrusion Detection and Prevention Systems

IDS	Intrusion Detection Systems
IPS	Intrusion Prevention Systems
IT	Information Technology
NVD	National Vulnerability Database
OSI	Open System Interconnection
PLC	Programmable Logic Controller
SCADA	Supervisory Control and Data Acquisition
SNMP	Simple Network Management Protocol
SSH	Secure Shell
SIEM	Security Information and Event Management
USB	Universal Serial Bus

## 4.1.11 References

- [1] Recommended Practice: Improving Industrial Control Systems Cybersecurity with Defense-In-Depth Strategies, October 2009  
[https://ics-cert.us-cert.gov/sites/default/files/FactSheets/NCCIC%20ICS\\_FactSheet\\_Defense\\_in\\_Depth\\_Strategies\\_S508C.pdf](https://ics-cert.us-cert.gov/sites/default/files/FactSheets/NCCIC%20ICS_FactSheet_Defense_in_Depth_Strategies_S508C.pdf)
- [2] NIST.SP.800-82 Guide to Industrial Control Systems (ICS) Security, June 2011  
<http://csrc.nist.gov/publications/nistpubs/800-82/SP800-82-final.pdf>
- [3] NIST.SP.800-94 Guide to Intrusion Detection and Prevention Systems (IDPS), Feb 2007  
<http://csrc.nist.gov/publications/nistpubs/800-94/SP800-94.pdf>
- [4] Common Cybersecurity Vulnerabilities in Industrial Control Systems, May 2011  
[http://ics-cert.uscert.gov/sites/default/files/recommended\\_practices/DHS\\_Common\\_Cybersecurity\\_Vulnerabilities\\_ICS\\_2010.pdf](http://ics-cert.uscert.gov/sites/default/files/recommended_practices/DHS_Common_Cybersecurity_Vulnerabilities_ICS_2010.pdf)
- [5] The Tao of Network Security Monitoring, 2005 Richard Bejtlich

## 4.2 Cybersecurity recommended secure hardening guidelines

### 4.2.1 Introduction

This Network module has been designed with Cybersecurity as an important consideration. Number of Cybersecurity features are now offered in the product which if implemented as per the recommendations in this section would minimize Cybersecurity risk to the Network module. This section "secure configuration" or "hardening" guidelines provide information to the users to securely deploy and maintain their product to adequately minimize the cybersecurity risks to their system.

Eaton is committed to minimizing the Cybersecurity risk in its products and deploys cybersecurity best practices and latest cybersecurity technologies in its products and solutions; making them more secure, reliable and competitive for our customers. Eaton also offers Cybersecurity Best Practices whitepapers to its customers that can be referenced at [www.eaton.com/cybersecurity](http://www.eaton.com/cybersecurity)

### 4.2.2 Secure configuration guidelines

#### 4.2.2.1 Asset identification and Inventory

Keeping track of all the devices in the system is a pre-requisite for effective management of Cybersecurity of a system. Ensure you maintain an inventory of all the components in your system in a manner in which you uniquely identify each component. To facilitate this Network module supports the following identifying information - manufacturer, type, serial number, f/w version number, and location.

##### 4.2.2.1.1 Network Module identification and its firmware information

It can be retrieved by navigating to *Card>>>System information*.

###### Identification

- System name
- Product
- Physical name
- Vendor
- UUID
- Part number
- Serial number
- Hardware version
- Location
- Contact

###### Firmware information

- Firmware version
- Firmware SHA
- Firmware date
- Firmware installation date
- Firmware activation date
- Bootloader version



The COPY TO CLIPBOARD button will copy the information to the clipboard.

##### 4.2.2.1.2 Communication settings

It can be retrieved by navigating to *Settings>>>Network*

###### LAN

- Link status
- MAC address

- Configuration

#### IPV4

- Status
- Mode
- Address
- Netmask
- Gateway

#### Domain

- Mode
- FQDN
- Primary DNS
- Secondary DNS

#### IPV6

- Status
- Mode
- Addresses

### 4.2.2.1.3 UPS details

It can be retrieved by navigating to *Home>>>Details*

#### Details

- Name
- Model
- P/N
- S/N
- Location
- FW version



The COPY TO CLIPBOARD button will copy the information to the clipboard.

### 4.2.2.2 Physical Protection

Industrial Control Protocols don't offer cryptographic protections at protocol level, at physical ports and at controller mode switches leaving them exposed to Cybersecurity risk. Physical security is an important layer of defense in such cases. Network module is designed with the consideration that it would be deployed and operated in a physically secure location.

- Physical access to cabinets and/or enclosures containing Network module and the associated system should be restricted, monitored and logged at all times.
- Physical access to the communication lines should be restricted to prevent any attempts of wiretapping, sabotage. It's a best practice to use metal conduits for the communication lines running between one cabinet to another cabinet.
- Attacker with unauthorized physical access to the device could cause serious disruption of the device functionality. A combination of physical access controls to the location should be used, such as locks, card readers, and/or guards etc.
- Network module supports the following physical access ports, controller mode switches and USB ports: RJ45, USB A, USB Micro-B. Access to them need to be restricted.
- Do not connect unauthorized USB device or SD card for any operation (e.g. Firmware upgrade, Configuration change and Boot application change).
- Before connecting any portable device through USB or SD card slot, scan the device for malwares and virus.

### 4.2.2.3 Authorization and Access Control

It is extremely important to securely configure the logical access mechanisms provided in Network module to safeguard the device from unauthorized access. Eaton recommends that the available access control mechanisms be used properly to ensure that

access to the system is restricted to legitimate users only. And, such users are restricted to only the privilege levels necessary to complete their job roles/functions.

- Ensure default credentials are changed upon first login. Network module should not be commissioned for production with Default credentials; it's a serious Cybersecurity flaw as the default credentials are published in the manuals.
- No password sharing – Make sure each user gets his/her own password for that desired functionality vs. sharing the passwords. Security monitoring features of Network module are created with the view of each user having his/her own unique password. Security controls will be weakened as soon as the users start sharing the password.
- Restrict administrative privileges - Threat actors are increasingly focused on gaining control of legitimate credentials, especially those associated with highly privileged accounts. Limit privileges to only those needed for a user's duties.
- Perform periodic account maintenance (remove unused accounts).
- Change passwords and other system access credentials whenever there is a personnel change.
- Use client certificates along with username and password as additional security measure.

Description of the User management in the Network Module:

- User and profiles management: (Navigate to Settings>>>Users)

Add users  
Remove users  
Edit users

- Password/Account/Session management: (Navigate to Settings>>>Users)

Password strength rules – Minimum length/Minimum upper case/Minimum lower case/Minimum digit/Special character  
Account expiration – Number of days before the account expiration/Number of tries before blocking the account  
Session expiration – No activity timeout/Session lease time

See "Default settings parameters" in the embedded help for (recommended) default values.

Additionally, it is possible to enable account expiration to force users renew their password periodically.

- Default credentials: admin/admin

The change of the default "admin" password is enforced at first connection.

It is also recommended to change the default "admin" user name through the *Settings>>>Users* page.

Follow embedded help for instructions on how to edit a user account.

- Server and client certificate configuration: (Navigate to Settings>>>Certificate)  
Follow embedded help for instructions on how to configure it.

#### 4.2.2.4 *Deactivate unused features*

Network module provides multiple options to upgrade firmware, change configurations, set power schedules, etc. The device also provide multiple options to connect with the device i.e. SSH, SNMP,SMTP,HTTPS etc. Services like SNMPv1 are considered insecure and Eaton recommends disabling all such insecure services.

- It is recommended to disable unused physical ports like USB and SD card.
- Disable insecure services like SNMP v1

### *Network Security*

Network module provides network access to facilitate communication with other devices in the systems and configuration. But this capability could open up a big security hole if it's not configured securely.

Eaton recommends segmentation of networks into logical enclaves and restrict the communication to host-to-host paths. This helps protect sensitive information and critical services and limits damage from network perimeter breaches. At a minimum, a utility Industrial Control Systems network should be segmented into a three-tiered architecture (as recommended by NIST SP800-82[R3]) for better security control.

Deploy adequate network protection devices like Firewalls, Intrusion Detection / Protection devices,

Please find detailed information about various Network level protection strategies in Eaton Cybersecurity Considerations for Electrical Distribution Systems [R1]. Use the below information for configuring the firewalls to allow needed access for Network module to operate smoothly.

- Navigate to *Information>>>Specifications/Technical characteristics>>>Port* to get the list of all ports and services running on the device.
- SNMP V1/SNMP V3 can be disabled or configured by navigating to *Settings>>>SNMP*. Instructions are available in the *Contextual help>>>Settings>>>SNMP*.

### 4.2.2.5 Logging and Event Management

#### Best Practices

- Eaton recommends that all remote interactive sessions are encrypted, logged, and monitored including all administrative and maintenance activities.
- Ensure that logs are backed up, retain the backups for a minimum of 3 months or as per organization's security policy.
- Perform log review at a minimum every 15 days.
- Navigate to *Information>>>List of events codes* to get log information and how to export it.

### 4.2.2.6 Secure Maintenance

#### Best Practices

#### 4.2.2.6.1 Apply Firmware updates and patches regularly

Due to increasing Cyber Attacks on Industrial Control Systems, Eaton implements a comprehensive patch and update process for its products. Users are encouraged to maintain a consistent process to promptly monitor for fresh firmware updates, implement patching and updates as and when required or released.

- Navigate in the help to *Contextual help>>>Card>>>Administration* to get information on how to upgrade the Network Module.
- Eaton also has a robust vulnerability response process. In the event of any security vulnerability getting discovered in its products, Eaton patches the vulnerability and releases information bulletin through its cybersecurity web site - <http://eaton.com/cybersecurity> and patch through [www.eaton.com/downloads](http://www.eaton.com/downloads).

#### Conduct regular Cybersecurity risk analyses of the organization /system.

Eaton has worked with third-party security firms to perform system audits, both as part of a specific customer's deployment and within Eaton's own development cycle process. Eaton can provide guidance and support to your organization's effort to perform regular cybersecurity audits or assessments.

#### 4.2.2.6.2 Plan for Business Continuity / Cybersecurity Disaster Recovery

It's a Cybersecurity best practice for organizations to plan for Business continuity. Establish an OT Business Continuity plan, periodically review and, where possible, exercise the established continuity plans. Make sure offsite backups include

- Backup of the latest f/w copy of Network module. Make it a part of SOP to update the backup copy as soon as the latest f/w is updated on Network module.
- Backup of the most current configurations.
- Documentation of the most current User List.
- Save and store securely the current configurations of the device.

## 4.2.3 References

[R1] *Cybersecurity Considerations for Electrical Distribution Systems (WP152002EN):*

[http://www.eaton.com/ecm/groups/public/@pub/@eaton/@corp/documents/content/pct\\_1603172.pdf](http://www.eaton.com/ecm/groups/public/@pub/@eaton/@corp/documents/content/pct_1603172.pdf)

[R2] *Cybersecurity Best Practices Checklist Reminder (WP910003EN):*

[http://www.cooperindustries.com/content/dam/public/powersystems/resources/library/1100\\_EAS/WP910003EN.pdf](http://www.cooperindustries.com/content/dam/public/powersystems/resources/library/1100_EAS/WP910003EN.pdf)

[R3] *NIST SP 800-82 Rev 2, Guide to Industrial Control Systems (ICS) Security, May 2015:*

<https://ics-cert.us-cert.gov/Standards-and-References>



[R4] National Institute of Technology (NIST) Interagency "Guidelines on Firewalls and Firewall Policy, NIST Special Publication 800-41", October 2009:

<http://nvlpubs.nist.gov/nistpubs/Legacy/SP/nistspecialpublication800-41r1.pdf>

## 4.3 Configuring user permissions through profiles

The user profile can be defined when creating a new users or changed when modifying an existing one.

Refer to the section [Users](#) in the settings.

## 4.4 Decommissioning the Network Management module

With the increased frequency of reported data breaches, it's becoming more and more necessary for companies to implement effective and reliable decommissioning policies and procedures.

In order to protect the data stored on retired IT equipment from falling into the wrong hands, or a data breach, we recommend to follow below decommissioning steps:

### 1- Sanitize the Network Module

Sanitization erases all the data (user name and password, certificates, keys, settings, logs...).

To sanitize the Network Module refer to: [Sanitization](#)

### 2- Unmount the Network Module from the device.

Unscrew the Network Module and remove it from the slot.

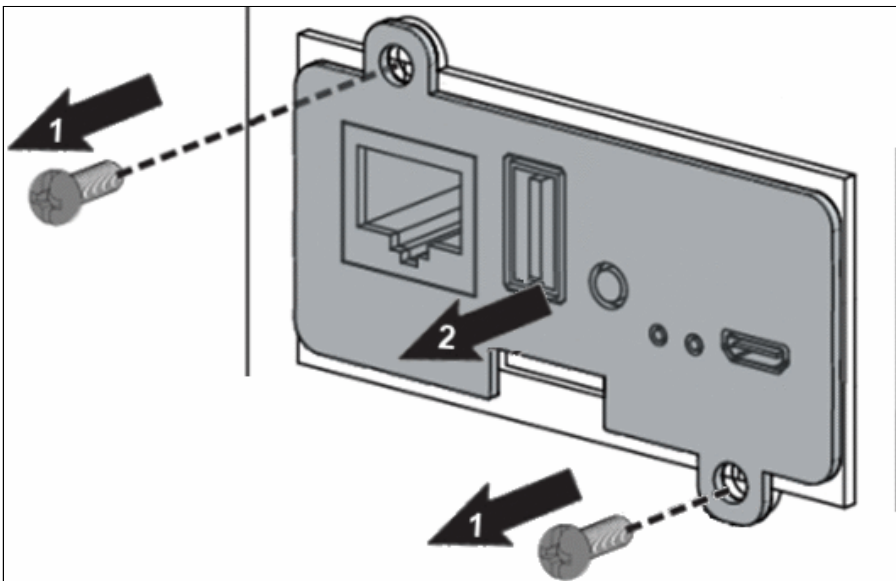

## 5 Servicing the EMP

### 5.1 Description and features

The optional Environmental Monitoring Probe (EMP) enables you to collect temperature and humidity readings and monitor the environmental data remotely.

You can also collect and retrieve the status of one or two dry contact devices (not included).

Up to 3 Environmental Monitoring Probe can be daisy chained on one device.

You can monitor readings remotely using SNMP or a standard Web browser through the Network module.

This provides greater power management control and flexible monitoring options.

The EMP device is delivered with a screw and screw anchor, magnets, nylon fasteners, tie wraps, and magnets. You can install the device anywhere on the rack or on the wall near the rack.



For more information, refer to the device manual.

The EMP has the following features:

- The hot-swap feature simplifies installation by enabling you to install the probe safely without turning off power to the device or to the loads that are connected to it.
- The EMP monitors temperature and humidity information to help you protect critical equipment.
- The EMP measures temperatures from 0°C to 70°C with an accuracy of  $\pm 2^\circ\text{C}$ .
- The EMP measures relative humidity from 10% to 90% with an accuracy of  $\pm 5\%$ .
- The EMP can be located some distance away from the device with a CAT5 network cable up to 50m (165 ft) long.
- The EMP monitors the status of the two user-provided contact devices.
- Temperature, humidity, and contact closure status can be displayed through a Web browser through the Network module or LCD interface (if available)
- A Temperature and Humidity Offset can be set.

### 5.2 Unpacking the EMP

The sensor will include the following:

- EMPDT1H1C2 sensor
- Dry contact terminal block
- Quickstart
- USB to RS485 converter
- RJ45 female to female connector
- Wall mounting screw and anchor
- Rack mounting screw nut and washer
- Tie wraps (x2)
- Nylon fastener



Packing materials must be disposed of in compliance with all local regulations concerning waste. Recycling symbols are printed on the packing materials to facilitate sorting.

## 5.3 Installing the EMP

### 5.3.1 Defining EMPs address and termination

#### 5.3.1.1 Manual addressing



Address must be defined before the EMP power-up otherwise the changes won't be taken into account.

Do not set Modbus address to 0, otherwise the EMP will not be detected.

Define **different address** for all the EMPs in the daisy-chain.

Set the RS485 termination (TER) to 1 on the last EMP of the daisy chain, set it to 0 on all the other EMPs.

##### 5.3.1.1.1 Example: manual addressing of 3 EMPs connected to the Device

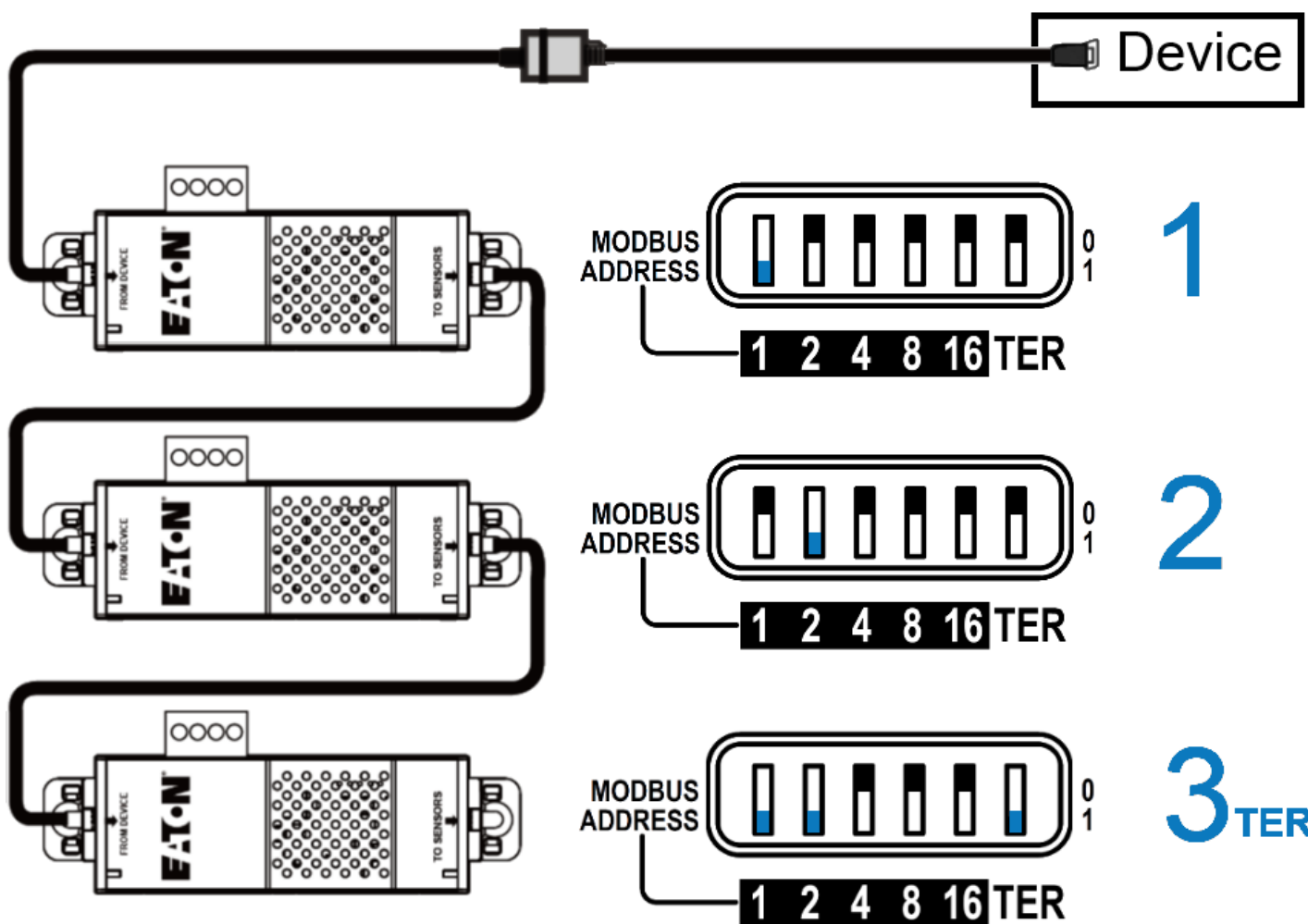

Green LED of the TO DEVICE RJ45 connector shows if the EMP is powered by the Network module.

### 5.3.2 Mounting the EMP

The EMP includes magnets, cable ties slots and keyholes to enable multiple ways of mounting it on your installation.

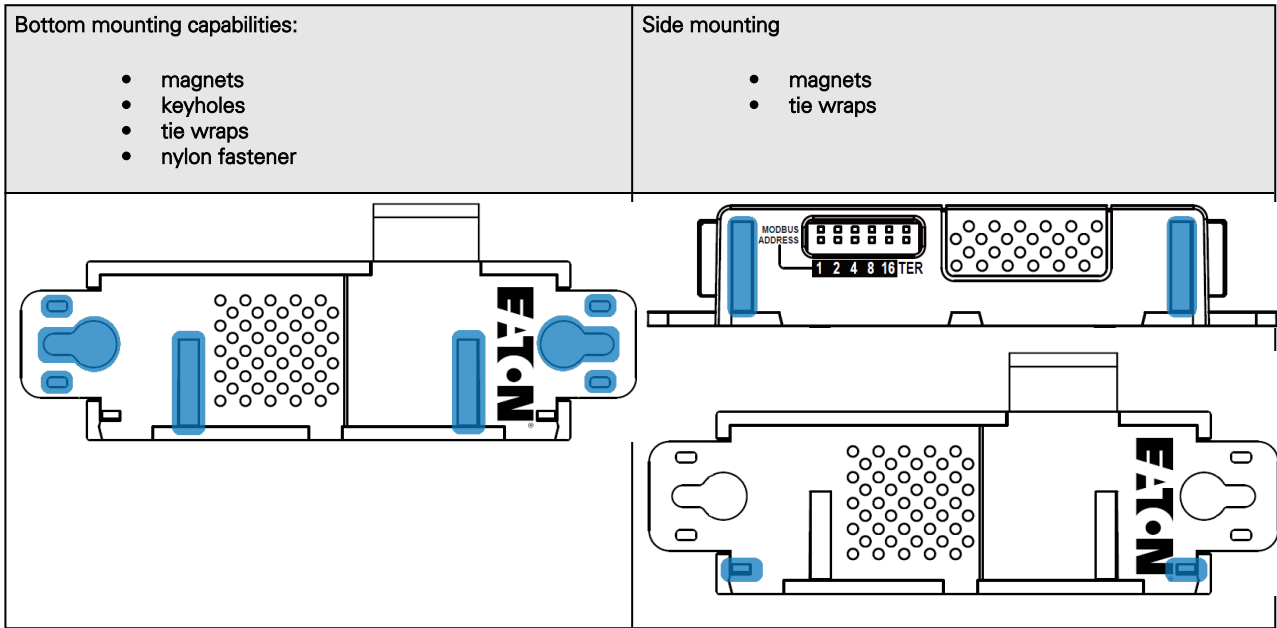

### 5.3.2.1 Rack mounting with keyhole example

To mount the EMP on the rack, use the supplied screw, washer and nut. Then, mount the EMP on the screw and tighten it.

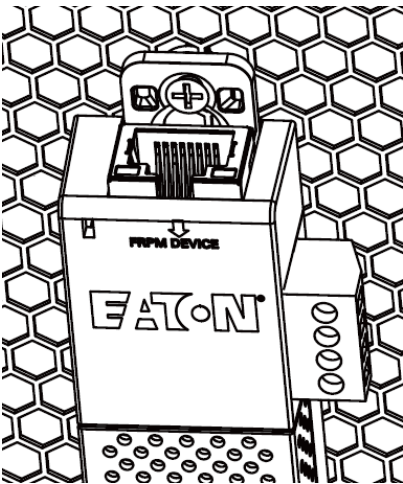

### 5.3.2.2 Rack mounting with tie wraps example

To mount the EMP on the door of the rack, use the supplied cable ties.

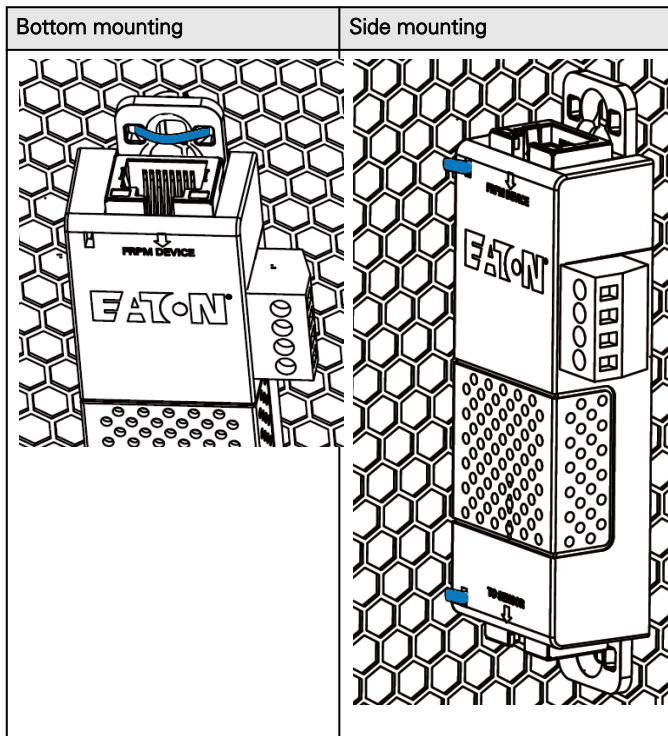

### 5.3.2.3 Wall mounting with screws example

To mount the EMP on the wall close to the rack, use the supplied screw and screw anchor. Then, mount the EMP on the screw and tighten it.

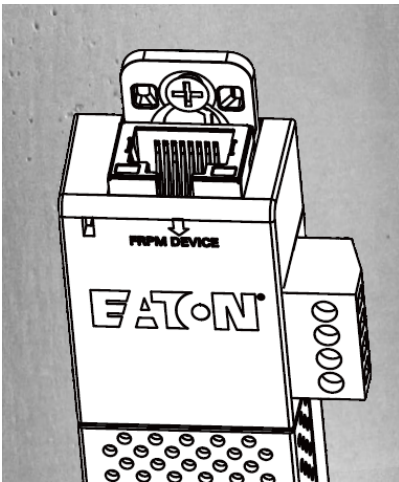

### 5.3.2.4 Wall mounting with nylon fastener example

To mount the EMP within the enclosure environment, attach one nylon fastener to the EMP and the other nylon fastener to an enclosure rail post. Then, press the two nylon strips together to secure the EMP to the rail post.



Cut nylon fastener and stick it on the EMP bottom on the location highlighted below, this will prevent to interfere with the EMP data acquisition parts.

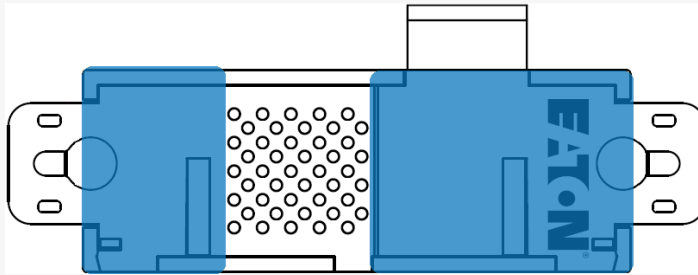

### 5.3.3 Cabling the first EMP to the device

#### 5.3.3.1 Available Devices

##### 5.3.3.1.1 Network-M2 and INDGW-M2

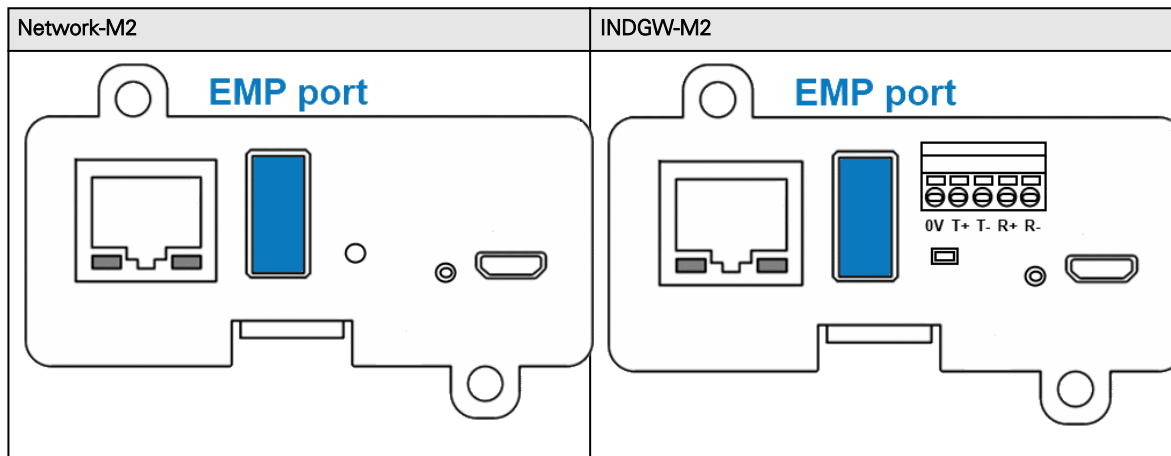

#### 5.3.3.2 Connecting the EMP to the device



Address must be defined before the EMP power-up otherwise the changes won't be taken into account.  
Do not set Modbus address to 0, otherwise the EMP will not be detected.

##### 5.3.3.2.1 Material needed:

- EMP
- RJ45 female/female connector (supplied in EMP accessories)
- USB to RS485 converter cable (supplied in EMP accessories)
- Ethernet cable (**not supplied**).
- Device

### 5.3.3.2.2 Connection steps

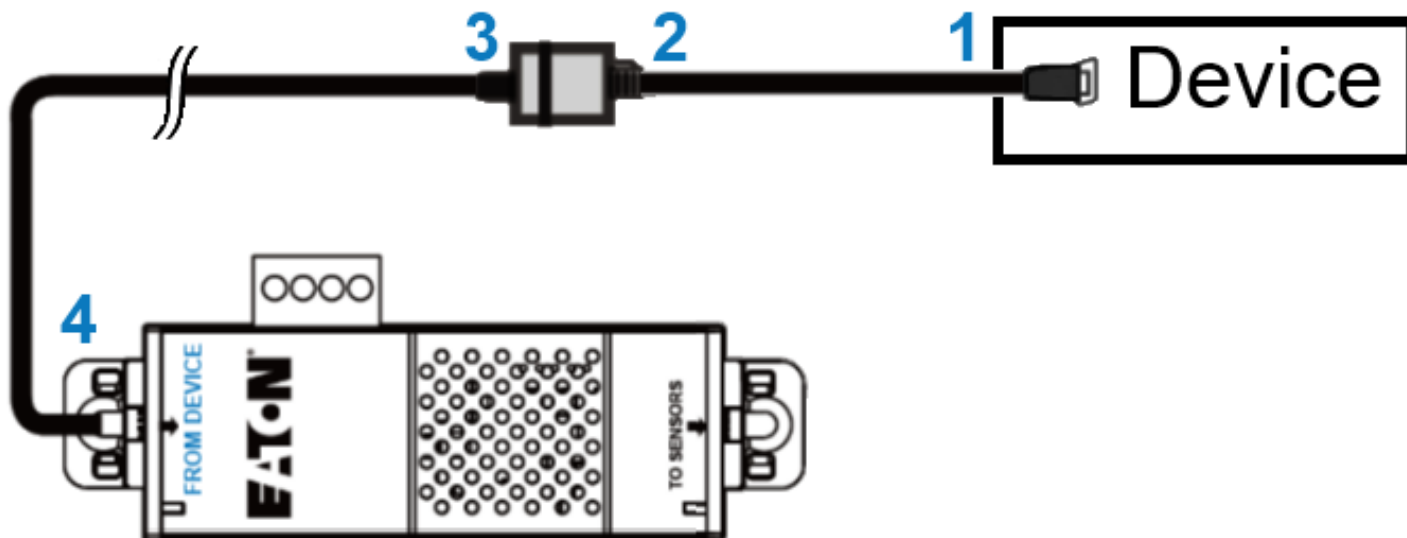

Step 1 – Connect the "USB to RS485 converter cable" to the USB port of the Device.

Step 2 – Connect the "USB to RS485 converter cable" to the RJ45 female/female connector.

Step 3 – Connect the Ethernet cable to the other end of the RJ45 female/female connector.

Step 4 – Connect the other end of the Ethernet cable to the RJ-45 port on the EMP (FROM DEVICE).



Use the supplied tie wraps to secure the "RS485 to USB cable" to the Network cable.

## 5.3.4 Daisy chaining EMPs



Address must be defined before the EMP power-up otherwise the changes won't be taken into account.

Do not set Modbus address to 0, otherwise the EMP will not be detected.

### 5.3.4.1 Material needed:

- First EMP connected to the device (refer to previous section)
- Additional EMPs
- 2 x Ethernet cable (**not supplied**).
- Device

### 5.3.4.2 Steps

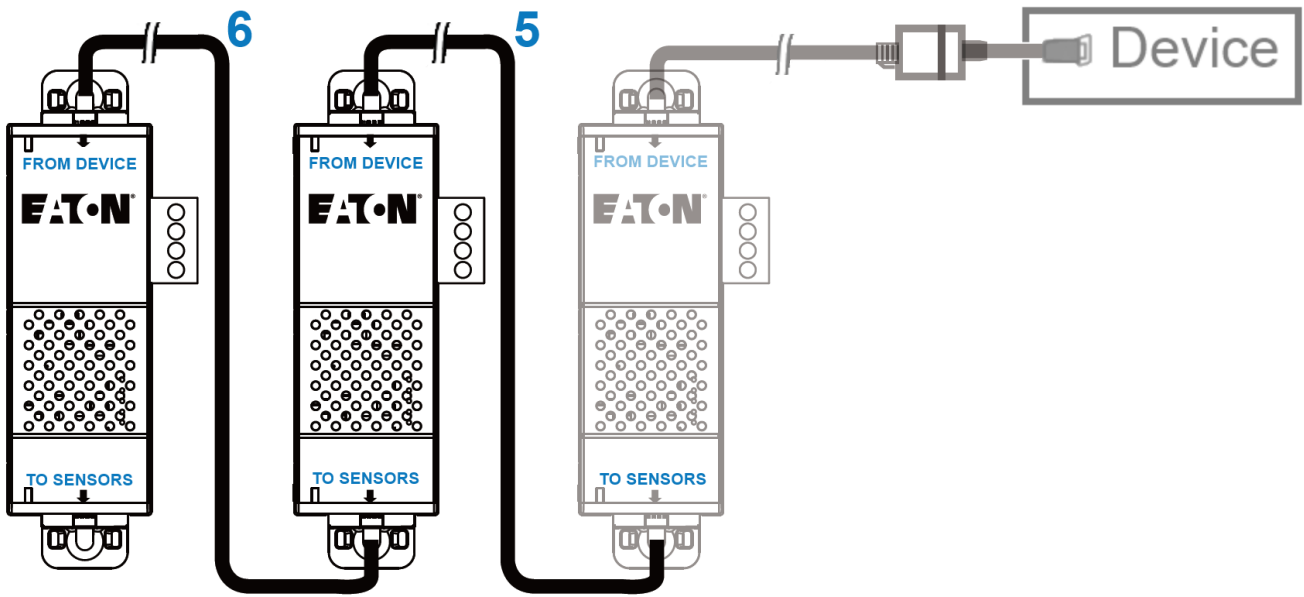

Up to 3 EMP can be daisy chained on one device.

STEP 5 – Connect the Ethernet cable to the "TO SENSORS" port of the first EMP, and to the "FROM DEVICE" port of the second EMP.

STEP 6 – Connect the Ethernet cable to the "TO SENSORS" port of the second EMP, and to the "FROM DEVICE" port of the third EMP.

### 5.3.5 Connecting an external contact device

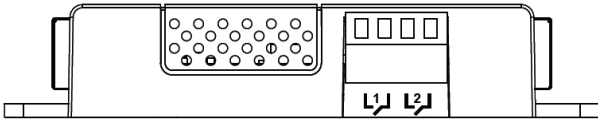

To connect an external device to the EMP:

1- Connect the external contact closure inputs to the terminal block on the EMP (see the table and the figure below):

- External contact device 1. Connect the return and signal input wires from device 1 to screw terminals 1.
- External contact device 2. Connect the return and signal input wires from device 2 to screw terminals 2.

2- Tighten the corresponding tightening screws on top of the EMP to secure the wires.

## 5.4 Commissioning the EMP

### 5.4.1 On the Network-M2 device

STEP 1: Connect to the Network Module

- On a network computer, launch a supported web browser. The browser window appears.
- In the Address/Location field, enter: <https://xxx.xxx.xxx.xxx/> where xxx.xxx.xxx.xxx is the IP address of the Network Module.
- The log in screen appears.
- Enter the user name in the User Name field.
- Enter the password in the Password field.



- Click **Sign In**. The Network Module web interface appears.

**STEP 2:** Navigate to **Cards/Commissioning** page

**STEP 3:** Proceed to the commissioning (refer to the contextual help for details: Cards>>>Commissioning (Sensors))

- Click **Discover**. The EMP connected to the Network module appears in the table.



When discovered, the orange LEDs of the EMP RJ45 connectors shows the data traffic. If the discovery process fails refer to the troubleshooting section.



The Sensor button on the left bar also appears, this will be reviewed on STEP4 .



- Press the pen logo to edit EMP information and access its settings.
- Click **Define offsets** to define temperature or humidity offsets if needed.

**STEP 4:** Define alarm configuration (refer to the contextual help for details: Sensors>>>Alarm configuration)

- Click on the **Sensors** menu that has just appeared on the left bar after the EMP discovery.
- Select the **Alarm configuration** page.
- Enable or disable alarms.
- Define thresholds, hysteresis and severity of temperature, humidity and dry contacts alarms.

## 5.5 Using the EMP for temperature compensated battery charging

This section applies only to UPS that provides temperature compensated battery charging option.



Address must be defined before the EMP is powered up; otherwise the changes won't be taken into account.

Do not set all the Modbus address to 0, otherwise the EMP will not be detected.

Define a **unique address** for all the EMPs in the daisy-chain.

Set the RS485 termination (TER) to 1 on the last EMP of the daisy chain. On other EMPs this should be set to 0.

### 5.5.1 Addressing the EMP

Set the address 31 to the sensor dedicated to the battery room temperature:

- Set all the Modbus address switches to 1 to set the EMP to the address 31 as indicated on the picture below:

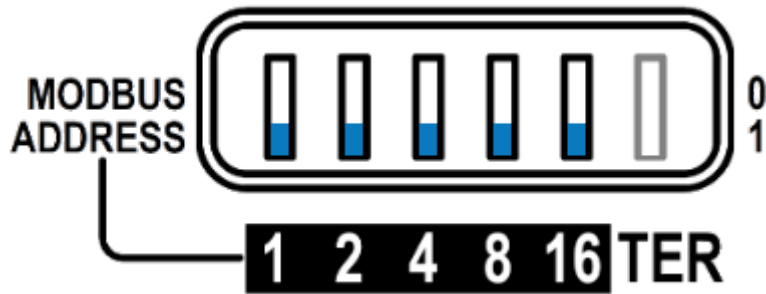

## 5.5.2 Commissioning the EMP

Refer to the section [Commissioning the EMP](#).

## 5.5.3 Enabling temperature compensated battery charging in the UPS





The temperature compensated battery charging feature needs to be enabled in the UPS.

To enable the temperature compensated battery charging, refer to the UPS user manual.

## 6 Information

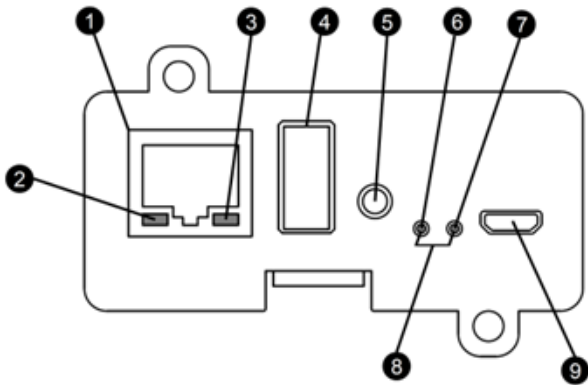
### 6.1 Front panel connectors and LED indicators



Nbr	Name	Description
<b>1</b>	Network connector	Ethernet port
<b>2</b>	Network speed LED	Flashing green sequences: <ul style="list-style-type: none"> <li>• 1 flash — Port operating at 10Mbps</li> <li>• 2 flashes — Port operating at 100Mbps</li> <li>• 3 flashes — Port operating at 1Gbps</li> </ul>
<b>3</b>	Network link/activity LED	<ul style="list-style-type: none"> <li>• Off — UPS Network Module is not connected to the network.</li> <li>• Solid yellow — UPS Network Module is connected to the network, but no activity detected.</li> <li>• Flashing yellow — UPS Network Module is connected to the network and sending or receiving data.</li> </ul>
<b>4</b>	AUX connector	For Network Module accessories only.  <div style="border: 1px solid black; padding: 5px; text-align: center;">  <b><i>Do not use for general power supply or USB charger.</i></b> </div>
<b>5</b>	Restart button	Ball point pen or equivalent will be needed to restart: <ul style="list-style-type: none"> <li>• Short press (&lt;6s) — Safe software restart (firmware safely shutdown before restart).</li> <li>• Long press (&gt;9s) — Forced hardware restart.</li> </ul>
<b>6</b>	ON LED	Flashing green — Network Module is operating normally.
<b>7</b>	Warning LED	Solid red — Network Module is in error state.

<b>8</b>	Boot LEDs	Solid green and flashing red — Network Module is starting boot sequence.
<b>9</b>	Settings/UPS data connector	Configuration port. Access to Network Module’s web interface through RNDIS (Emulated Network port). Access to the Network Module console through Serial (Emulated Serial port).

## 6.2 Default settings and possible parameters

### 6.2.1 Settings

#### 6.2.1.1 General

	Default setting	Possible parameters
<b>General</b>	Location — empty Contact — empty System name — empty	Location — 31 characters maximum Contact — 255 characters maximum System name — 255 characters maximum

#### 6.2.1.2 Date & Time

	Default setting	Possible parameters
<b>Date &amp; Time</b>	Mode — Manual (Time zone: Europe/Paris)	Mode — Manual (Time zone: selection on map/Date) / Dynamic (NTP)

#### 6.2.1.3 Users

	Default setting	Possible parameters
<b>Password strength</b>	Minimum length — enabled (8) Minimum upper case — enabled (1) Minimum lower case — enabled (1) Minimum digit — enabled (1) Special character — enabled (1)	Minimum length — enable (6-32)/disable Minimum upper case — enable (0-32)/disable Minimum lower case — enable (0-32)/disable Minimum digit — enable (0-32)/disable Special character — enable (0-32)/disable
<b>Account expiration</b>	Password expires after — disabled Main administrator password never expires — disabled Block account when invalid password is entered after — disabled Main administrator account never blocks — disabled	Password expires after — disable/enable (1-99999) Main administrator password never expires — disable/enable Block account when invalid password is entered after — disable/enable (1-99) Main administrator account never blocks — disable/enable
<b>Session expiration</b>	No activity timeout — 60 minutes Session lease time — 120 minutes	No activity timeout — 1-60 minutes Session lease time — 60-720 minutes

<b>Local users</b>	1 user only: <ul style="list-style-type: none"><li>• Active — Yes</li><li>• Profile — Administrator</li><li>• Username — admin</li><li>• Full Name — blank</li><li>• Email — blank</li><li>• Phone — blank</li><li>• Organization — blank</li></ul>	10 users maximum: <ul style="list-style-type: none"><li>• Active — Yes/No</li><li>• Profile — Administrator/Operator/Viewer</li><li>• Username — 255 characters maximum</li><li>• Full Name — 128 characters maximum</li><li>• Email — 128 characters maximum</li><li>• Phone — 64 characters maximum</li><li>• Organization — 128 characters maximum</li></ul>
--------------------	---	---

<p><b>LDAP</b></p>	<p>Configure</p> <ul style="list-style-type: none"> <li>• Active – No</li> <li>• Security SSL – SSL Verify server certificate – enabled</li> <li>• Primary server Name – Primary Hostname – blank Port – 636</li> <li>• Secondary server Name – blank Hostname – blank Port – blank</li> <li>• Credentials Anonymous search bind – disabled Search user DN – blank Password – blank</li> <li>• Search base Search base DN – dc=example,dc=com</li> <li>• Request parameters User base DN – ou=people,dc=example,dc=com User name attribute – uid UID attribute – uidNumber Group base DN – ou=group,dc=example,dc=com Group name attribute – gid GID attribute – gidNumber</li> </ul> <p>Profile mapping – no mapping</p> <p>Users preferences</p> <ul style="list-style-type: none"> <li>• Language –English</li> <li>• Temperature unit – °C (Celsius)</li> <li>• Date format – MM-DD-YYYY</li> <li>• Time format – hh:mm:ss (24h)</li> </ul>	<p>Configure</p> <ul style="list-style-type: none"> <li>• Active – No/yes</li> <li>• Security SSL – None/Start TLS/SSL Verify server certificate – disabled/ enabled</li> <li>• Primary server Name – 128 characters maximum Hostname – 128 characters maximum Port – x-xxx</li> <li>• Secondary server Name – 128 characters maximum Hostname – 128 characters maximum Port – x-xxx</li> <li>• Credentials Anonymous search bind – disabled/ enabled Search user DN – 1024 characters maximum Password – 128 characters maximum</li> <li>• Search base Search base DN – 1024 characters maximum</li> <li>• Request parameters User base DN – 1024 characters maximum</li> </ul> <p>User name attribute – 1024 characters maximum UID attribute – 1024 characters maximum Group base DN – 1024 characters maximum</p> <p>Group name attribute – 1024 characters maximum GID attribute – 1024 characters maximum</p> <p>Profile mapping – up to 5 remote groups mapped to local profiles, the group name must fulfil the following conditions :</p> <ul style="list-style-type: none"> <li>• 1 character minimum</li> <li>• 255 characters maximum</li> <li>• First character alphanumeric or underscore</li> <li>• Other characters alphanumeric, underscore or hyphen</li> </ul> <p>Users preferences</p> <ul style="list-style-type: none"> <li>• Language –German/English/Spanish/ French/Italian/Japanese/Simplified Chinese/Traditional Chinese</li> <li>• Temperature unit – °C (Celsius)/°F (Fahrenheit)</li> <li>• Date format – MM-DD-YYYY / YYYY-MM- DD / DD-MM-YYY / DD.MM.YYY / DD/ MM/YYY / DD MM YYYY</li> <li>• Time format – hh:mm:ss (24h) / hh:mm:ss (12h)</li> </ul>
--------------------	---	---

<b>RADIUS</b>	Configure <ul style="list-style-type: none"> <li>• Active – No</li> <li>• Retry number – 0</li> <li>• Primary server Name – blank Secret – blank Address – blank UDP port – 1812 Time out – 3</li> <li>• Secondary server Name – blank Secret – blank Address – blank UDP port – 1812 Time out – 3</li> </ul>	Configure <ul style="list-style-type: none"> <li>• Active – Yes/No</li> <li>• Retry number – 0 to 128</li> <li>• Primary server Name – 128 characters maximum Address – 128 characters maximum Secret – 128 characters maximum UDP port – 1 to 65535 Time out – 3 to 60</li> <li>• Secondary server Name – 128 characters maximum Address – 128 characters maximum Secret – 128 characters maximum UDP port – 1 to 65535 Time out – 3 to 60</li> </ul>
	Users preferences <ul style="list-style-type: none"> <li>• Language –English</li> <li>• Temperature unit – °C (Celsius)</li> <li>• Date format – MM-DD-YYYY</li> <li>• Time format – hh:mm:ss (24h)</li> </ul>	Users preferences <ul style="list-style-type: none"> <li>• Language – German/English/Spanish/French/Italian/Japanese/ Simplified Chinese/Traditional Chinese</li> <li>• Temperature unit – °C (Celsius)</li> <li>• Date format – MM-DD-YYYY</li> <li>• Time format – hh:mm:ss (24h)</li> </ul>

### 6.2.1.4 Network

	Default setting	Possible parameters
<b>LAN</b>	Configuration — Auto negotiation	Configuration — Auto negotiation - 10Mbps - Half duplex - 10Mbps - Full duplex - 100Mbps - Half duplex - 100Mbps - Full duplex - 1.0 Gbps - Full duplex
<b>IPV4</b>	Mode — Dynamic (DHCP)	Mode — DHCP/Manual (IP address/Netmask/Gateway)
<b>Domain</b>	Domain configuration (more) : <ul style="list-style-type: none"> <li>• Hostname — ups-[MAC address]</li> <li>• Mode — DHCP</li> </ul>	Domain configuration (more) : <ul style="list-style-type: none"> <li>• Hostname — 128 characters maximum</li> <li>• Mode :DHCP/Manual (Domain name/Primary DNS/Secondary DNS)</li> </ul>
<b>IPV6</b>	Enable — checked IPV6 details (more) : <ul style="list-style-type: none"> <li>• Mode — Router</li> </ul>	Enable — enable/disable IPV6 details (more) : <ul style="list-style-type: none"> <li>• Mode — Router/Manual (Address/Prefix/Gateway)</li> </ul>

### 6.2.1.5 Protocols

	Default setting	Possible parameters
<b>HTTPS</b>	Port — 443	Port — x-xxx

<b>Syslog</b>	<p>Enable — disabled</p> <ul style="list-style-type: none"> <li>• Server#1</li> </ul> <p>Name – Primary Active – No Hostname – empty Port – 514 Protocol – UDP Message transfer method – Non transparent framing Using unicode byte order mask (BOM) – disabled</p> <ul style="list-style-type: none"> <li>• Server#2</li> </ul> <p>Name – empty Active – No Hostname – empty Port – 514 Protocol – UDP Message transfer method – Disabled in UDP Using unicode byte order mask (BOM) – disabled</p>	<p>Enable — disable/enable</p> <ul style="list-style-type: none"> <li>• Server#1</li> </ul> <p>Name – 128 characters maximum Active – No/Yes Hostname – 128 characters maximum Port – x-xxx Protocol – UDP/TCP Message transfer method – Non transparent framing Using unicode byte order mask (BOM) – disable/enable</p> <ul style="list-style-type: none"> <li>• Server#2</li> </ul> <p>Name – 128 characters maximum Active – No/Yes Hostname – 128 characters maximum Port – x-xxx Protocol – UDP/TCP Message transfer method (in TCP) – Octet counting/Non transparent framing Using unicode byte order mask (BOM) – disable/enable</p>
---------------	--	--

### 6.2.1.6 SNMP

	Default setting	Possible parameters
--	-----------------	---------------------



<p><b>SNMP</b></p>	<p>Enable — disabled                  Port — 161                  SNMP V1 — disabled</p> <ul style="list-style-type: none"> <li>Community #1 — public                      Active — No                      Access — Read only</li> <li>Community #2 — private                      Active — No                      Access — Read/Write</li> </ul> <p>SNMP V3 — enabled</p> <ul style="list-style-type: none"> <li>User #1 — readonly                      Active — No                      Access — Read only                      Security — Auth, Priv                      Authentication algorithm — SHA256                      Password — empty                      Confirm password — empty                      Privacy algorithm — AES                      Key — empty                      Confirm key — empty</li> <li>User#2 — readwrite                      Active — No                      Access — Read/Write                      Security — Auth, Priv                      Authentication algorithm — SHA256                      Password — empty                      Confirm password — empty                      Privacy — Secured - AES                      Key — empty                      Confirm key — empty</li> </ul>	<p>Enable — disable/enable                  Port — x-xxx                  SNMP V1 — disable/enable</p> <ul style="list-style-type: none"> <li>Community #1 — 128 characters maximum                      Active — No/Yes                      Access — Read only</li> <li>Community #2 — 128 characters maximum                      Active — No/Yes                      Access — Read/Write</li> </ul> <p>SNMP V3 — disable/enable</p> <ul style="list-style-type: none"> <li>User #1 — 32 characters maximum                      Active — No/Yes                      Access — Read only/Read-Write                      Security — No Auth, No Priv / Auth, No Priv / Auth, Priv                      Authentication algorithm — SHA / SHA256 / SHA384 / SHA512                      Password — 128 characters maximum                      Confirm password — 128 characters maximum                      Privacy algorithm — AES / AES192 / AES256                      Key — 128 characters maximum                      Confirm key — 128 characters maximum</li> <li>User#2 — 32 characters maximum                      Active — No/Yes                      Access — Read only/Read-Write                      Security — No Auth, No Priv / Auth, No Priv / Auth, Priv                      Authentication algorithm — SHA / SHA256 / SHA384 / SHA512                      Password — 128 characters maximum                      Confirm password — 128 characters maximum                      Privacy algorithm — AES / AES192 / AES256                      Key — 128 characters maximum                      Confirm key — 128 characters maximum</li> </ul>
<p><b>Trap receivers</b></p>	<p>No trap</p>	<p>Active — No/Yes                  Application name — 128 characters maximum                  Hostname or IP address — 128 characters maximum                  Port — x-xxx                  Protocol — V1                  Trap community — 128 characters maximum</p>

### 6.2.1.7 Certificate

	Default setting	Possible parameters
--	-----------------	---------------------

<b>Local certificates</b>	Country — FR	Country — Country code
	State or Province — 38	State or Province — 64 characters maximum
	City or Locality — Grenoble	City or Locality — 64 characters maximum
	Organization name — Eaton	Organization name — 64 characters maximum
	Organization unit — Power quality	Organization unit — 64 characters maximum
	Contact email address — blank	Contact email address — 64 characters maximum

### 6.2.1.8 Email

	Default setting	Possible parameters
<b>Email sending configuration</b>	No email	5 configurations maximum Active — No/Yes Configuration name — 128 characters maximum Email address — 128 characters maximum <ul style="list-style-type: none"> <li>• Notify on events Active — No/Yes On card events – Subscribe/Attach logs (Critical/Warning/Info) On devices events – Subscribe/Attach logs (Critical/Warning/Info) Exceptions on events notification – Always notify events with code/Never notify events with code</li> <li>• Periodic report Active — No/Yes Recurrence – Every day/Every week/Every month Starting – Date and time Topic – Subscribe/Attach logs (Card/Devices)</li> <li>• Email configuration Sender – text field/list of customization key words Subject – text field/list of customization key words</li> </ul>
<b>SMTP</b>	Server IP/Hostname — blank SMTP server authentication — disabled Port — 25 Sender address — ups@networkcard.com Secure SMTP connection — enabled Verify certificate authority — disabled	Server IP/Hostname — 128 characters maximum SMTP server authentication — disable/enable (Username/Password — 128 characters maximum) Port — x-xxx Sender address — 128 characters maximum Secure SMTP connection — enable/disable Verify certificate authority — disable/enable

### 6.2.1.9 My preferences

	Default setting	Possible parameters
--	-----------------	---------------------

<b>Profile</b>	Edit user: <ul style="list-style-type: none"> <li>• Full name — Administrator</li> <li>• Email — blank</li> <li>• Phone — blank</li> <li>• Organization — blank</li> </ul>	Edit user: <ul style="list-style-type: none"> <li>• Full name — 128 characters maximum</li> <li>• Email — 128 characters maximum</li> <li>• Phone — 64 characters maximum</li> <li>• Organization — 128 characters maximum</li> </ul>
<b>Temperature</b>	°C (Celsius)	°C (Celsius)/°F (Fahrenheit)
<b>Date format</b>	MM-DD-YYYY	MM-DD-YYYY / YYYY-MM-DD / DD-MM-YYY / DD.MM.YYY / DD/MM/YYYY / DD MM YYYY
<b>Time format</b>	hh:mm:ss (24h)	hh:mm:ss (24h) / hh:mm:ss (12h)
<b>Language</b>	English	Language — German/English/Spanish/French/Italian/Japanese/Simplified Chinese/Traditional Chinese

## 6.2.2 Meters

	Default setting	Possible parameters
<b>Configuration</b>	Log measures every — 60s	Log measures every — 3600s maximum

## 6.2.3 Sensors alarm configuration

	Default setting	Possible parameters
<b>Temperature</b>	Enabled — No Low critical — 0°C/32°F Low warning — 10°C/50°F High warning — 70°C/158°F High critical — 80°C/176°F	Enabled — No/Yes low critical<low warning<high warning<high critical
<b>Humidity</b>	Enabled — No Low critical — 10% Low warning — 20% High warning — 80% High critical — 90%	Enabled — No/Yes 0%<low critical<low warning<high warning<high critical<100%
<b>Dry contacts</b>	Enabled — No Alarm severity — Warning	Enabled — No/Yes Alarm severity — Info/Warning/Critical

## 6.3 Specifications/Technical characteristics

Physical characteristics	
Dimensions (wxdxh)	132 x 66 x 42 mm   5.2 x 2.6 x 1.65 in
Weight	70 g   0.15 lb
RoHS	100% compatible
Storage	
Storage temperature	-25°C to 70°C (14°F to 158°F)
Ambient conditions	
Operating temperature	0°C to 70°C (32°F to 158°F)
Relative humidity	5%-95%, noncondensing
Module performance	
Module input power	5V-12V ±5%   1A
AUX output power	5V ±5%   200mA
Date/Time backup	CR1220 battery coin cell   The RTC is able to keep the date and the time when Network Module is OFF
Functions	
Languages	English, French, Italian, German, Spanish, Japanese,
Alarms/Log	Email, SNMP trap, web interface / Log on events
Network	Gigabit ETHERNET, 10/100/1000Mb/s, auto negotiation, HTTP 1.1, SNMP V1, SNMP V3, NTP, SMTP, DHCP
Security	Restricted to TLS 1.2
Supported MIBs	<i>xUPS MIB   Standard IETF UPS MIB (RFC 1628)   Sensor MIB</i>
Browsers	Internet Explorer, Google Chrome, Firefox, Safari
Settings (default values)	
IP network	DHCP enabled   NTP server: pool.ntp.org
Port	443 (https), 22 (ssh), 161 (snmp), 162 (snmp trap), 25 (smtp), 8883 (mqttps), 123 (ntp), 5353 (mdns-sd), 80 (http), 514 (syslog), 636 (LDAP), 1812 (RADIUS)
Web interface access control	User name: admin   Password: admin
Settings/UPS data connector	USB RNDIS Apipa compatible   IP address: 169.254.0.1   Subnet mask: 255.255.0.0

## 6.4 List of event codes

To get access to the Alarm log codes or the System log codes for email subscription, see the [Alarm log codes](#) and [System log codes](#) sections.

## 6.5 Alarm log codes



To retrieve Alarm logs, navigate to Alarm section and press the **Download alarms** button.



Below codes are the one to be used to add "Exceptions on events notification" on email sending configurations.  
Some zeros maybe added in front of the code when displayed in emails or logs.

## 6.5.1 Critical

Code	Severity	Active message	Non-active message	Advice
002	Critical	Internal failure	End of internal failure	Service required
004	Critical	Temperature alarm	Temperature OK	Check air conditioner
007	Critical	Fan fault	Fan OK	Service required
00F	Critical	Parallel UPS not compatible	Parallel UPS compatibility OK	Service required
010	Critical	UPS power supply fault	UPS power supply OK	Service required
011	Critical	Parallel UPS protection lost	Parallel UPS protection OK	Reduce output load
012	Critical	Parallel UPS measure inconsistent	Parallel UPS measure OK	Service required
100	Critical	Rectifier fuse fault	Rectifier fuse OK	Service required
105	Critical	Input AC module failure	Input AC module OK	Service required
110	Critical	Building alarm (through dry contact)	Building alarm OK	-
11F	Critical	Building alarm (through Network module)	Building alarm OK	-
202	Critical	Bypass thermal overload	Bypass thermal OK	Reduce output load
203	Critical	Bypass temperature alarm	Bypass temperature OK	Check air conditioner
207	Critical	Bypass AC module failure	Bypass AC module OK	-
208	Critical	Bypass overload	No bypass overload	-
305	Critical	Rectifier failure	Rectifier OK	Service required
306	Critical	Rectifier overload	Rectifier OK	Reduce output load
308	Critical	Rectifier short circuit	Rectifier OK	Reduce output load
400	Critical	DCDC converter failure	DCDC converter OK	Service required
500	Critical	Battery charger fault	Battery charger OK	Service required
600	Critical	Battery fuse fault	Battery fuse OK	Service required
602	Critical	Battery fuse fault	Battery fuse OK	Service required
604	Critical	Battery low	Battery OK	-
607	Critical	Battery test failed	Battery test OK	Check battery
60D	Critical	No battery	Battery present	Check battery
629	Critical	Battery voltage low critical	Battery voltage OK	Check battery
62B	Critical	Battery voltage high critical	Battery voltage OK	Check battery
62D	Critical	Battery charge current low critical	Battery charge current OK	Check battery
62F	Critical	Battery charge current high critical	Battery charge current OK	Check battery
631	Critical	Battery discharge current low critical	Battery discharge current OK	Check battery
633	Critical	Battery discharge current high critical	Battery discharge current OK	Check battery
635	Critical	Battery temperature low critical	Battery temperature OK	Check battery

637	Critical	Battery temperature high critical	Battery temperature OK	Check battery
63E	Critical	Battery fault	Battery OK	Check battery
700	Critical	Inverter limitation	No current limitation	Reduce output load
701	Critical	Inverter fuse fault	Inverter fuse OK	Service required
704	Critical	Inverter internal failure	UPS OK	Service required
705	Critical	Inverter overload	No power overload	Reduce output load
706	Critical	Temperature alarm	Temperature OK	Check air conditioner
70A	Critical	Inverter thermal overload	No power overload	Reduce output load
70B	Critical	Inverter short circuit	End of inverter short circuit	Service required
802	Critical	Shutdown imminent	Shutdown canceled	-
805	Critical	Output short circuit	Output OK	Reduce output load
806	Critical	Emergency power OFF	No emergency OFF	-
811	Critical	Parallel negative power	Parallel power OK	Reduce output load
814	Critical	Firmware watchdog reset	Firmware watchdog OK	Service required
815	Critical	Calibration fault	Calibration OK	Service required
81E	Critical	Load unprotected	Load protected	-
900	Critical	Maintenance bypass	Not on maintenance bypass	-
1201	Critical	Temperature is critically low ( <i>EMP</i> )	Temperature is back to low ( <i>EMP</i> )	-
1204	Critical	Temperature is critically high ( <i>EMP</i> )	Temperature is back to high ( <i>EMP</i> )	-
1211	Critical	Humidity is critically low ( <i>EMP</i> )	Humidity is back to low ( <i>EMP</i> )	-
1214	Critical	Humidity is critically high ( <i>EMP</i> )	Humidity is back to high ( <i>EMP</i> )	-

## 6.5.2 Warning

Code	Severity	Active message	Non-active message	Advice
001	Warning	On battery	No more on battery	-
00B	Warning	Parallel UPS redundancy lost	Parallel UPS redundancy OK	Reduce output load
00E	Warning	Parallel UPS communication lost	Parallel UPS communication OK	Service required
103	Warning	Utility breaker open	Utility breaker closed	-
104	Warning	Input AC frequency out of range	Input AC frequency in range	-
106	Warning	Input AC not present	Input AC present	-
107	Warning	Input bad wiring	Input wiring OK	Check input wiring
108	Warning	Input AC voltage out of range (-)	Input AC voltage in range	-
109	Warning	Input AC voltage out of range (+)	Input AC voltage in range	-
10A	Warning	Input AC unbalanced	End of input AC unbalanced	-
200	Warning	Bypass phase out range	Bypass phase in range	-
201	Warning	Bypass not available	Bypass available	Service required
204	Warning	Bypass breaker open	Bypass breaker closed	-
205	Warning	Bypass mode	No more on bypass	-
206	Warning	Bypass frequency out of range	Bypass frequency in range	-
209	Warning	Bypass voltage out of range	Bypass voltage in range	-

20A	Warning	Bypass AC over voltage	End of bypass AC over voltage	-
20B	Warning	Bypass AC under voltage	End of bypass AC under voltage	-
20C	Warning	Bypass bad wiring	Bypass wiring OK	Check bypass wiring
300	Warning	DC bus + too high	DC bus + voltage OK	Service required
301	Warning	DC bus - too high	DC bus - voltage OK	Service required
302	Warning	DC bus + too low	DC bus + voltage OK	Service required
303	Warning	DC bus - too low	DC bus - voltage OK	Service required
304	Warning	DC bus unbalanced	DC bus OK	Service required
501	Warning	Charger temperature alarm	Charger temperature OK	Service required
502	Warning	Max charger voltage	Charger voltage OK	Service required
503	Warning	Min charger voltage	Charger voltage OK	Service required
603	Warning	Battery discharging	End of UPS battery discharge	-
605	Warning	Battery temperature alarm	Battery temperature OK	Service required
606	Warning	Battery breaker open	Battery breaker closed	Service required
610	Warning	Battery low voltage	Battery voltage OK	Check battery
613	Warning	Battery voltage too high	Battery voltage OK	Check battery
616	Warning	Battery voltage unbalanced	Battery voltage OK	Check battery
61C	Warning	Communication with battery lost	Communication with battery recovered	Check battery
61E	Warning	At least one breaker in battery is open	All battery breakers are closed	Check battery
61F	Warning	Battery State Of Charge below limit	Battery State Of Charge OK	-
620	Warning	Battery State Of Health below limit	BatteryState Of Health OK	Check battery
628	Warning	Battery voltage low warning	Battery voltage OK	Check battery
62A	Warning	Battery voltage high warning	Battery voltage OK	Check battery
62C	Warning	Battery charge current low warning	Battery charge current OK	Check battery
62E	Warning	Battery charge current high warning	Battery charge current OK	Check battery
630	Warning	Battery discharge current low warning	Battery discharge current OK	Check battery
632	Warning	Battery discharge current high warning	Battery discharge current OK	Check battery
634	Warning	Battery temperature low warning	Battery temperature OK	Check battery
636	Warning	Battery temperature high warning	Battery temperature OK	Check battery
638	Warning	Battery BMS failure	Battery BMS OK	Check battery
639	Warning	Battery temperature unbalanced	Battery temperature OK	Check battery
63D	Warning	Battery warning	Battery OK	Check battery
70C	Warning	Inverter voltage too low	Inverter voltage OK	Service required
70D	Warning	Inverter voltage too high	Inverter voltage OK	Service required
801	Warning	Load not powered	Load powered	-
803	Warning	Output breaker open	Output breaker closed	-
808	Warning	Power overload	No power overload	Reduce output load
80D	Warning	Internal configuration failure	Internal configuration OK	Service required

80E	Warning	Overload pre-alarm	No overload pre-alarm	Reduce output load
810	Warning	Overload alarm	No overload	Reduce output load
816	Warning	Compatibility failure	Compatibility OK	Service required
817	Warning	Output over current	No output over current	Reduce output load
818	Warning	Output frequency out of range	Output frequency in range	Service required
819	Warning	Output voltage too high	Output voltage OK	Service required
81A	Warning	Output voltage too low	Output voltage OK	Service required
81B	Warning	UPS Shutoff requested	End of UPS shutoff requested	Service required
81D	Warning	Load not powered	Load protected	-
901	Warning	Maintenance bypass breaker closed	Maintenance bypass breaker open	-
B00	Warning	End of warranty	End of warranty cleared	-
B01	Warning	Batteries are aging. Consider replacement	Batteries aging condition cleared	-
1032	Warning	Protection: immediate shutdown in progress	Protection: immediate shutdown completed	-
1053	Warning	Protection: communication lost with agent	Protection: communication recovered with agent	-
1200	Warning	Communication lost ( <i>with EMP</i> )	Communication recovered ( <i>EMP</i> )	-
1202	Warning	Temperature is low ( <i>EMP</i> )	Temperature is back to normal ( <i>EMP</i> )	-
1203	Warning	Temperature is high ( <i>EMP</i> )	Temperature is back to normal ( <i>EMP</i> )	-
1212	Warning	Humidity is low ( <i>EMP</i> )	Humidity is back to normal ( <i>EMP</i> )	-
1213	Warning	Humidity is high ( <i>EMP</i> )	Humidity is back to normal ( <i>EMP</i> )	-

### 6.5.3 Info

Code	Severity	Active message	Non-active message	Advice
005	Info	Communication lost (with UPS)	Communication recovered (with UPS)	Service required
009	Info	On high efficiency / On ESS mode	High efficiency disabled / ESS disabled	-
013	Info	Upgrading: limited communication	End of upgrade mode	-
101	Info	On AVR (Boost)	End of AVR (Boost)	-
102	Info	On AVR (Buck)	End of AVR (Buck)	-
63C	Info	Battery information	Battery OK	-
A00	Info	Group 1 is OFF	Group 1 is ON	-
A01	Info	Group 2 is OFF	Group 2 is ON	-
A0F	Info	Group is OFF	Group is ON	-
1016	Info	Protection: sequential shutdown scheduled	Protection: sequential shutdown canceled	-
1017	Info	Protection: sequential shutdown in progress	Protection: sequential shutdown completed	-



1054	Info	Protection: agent is in unknown state	Protection: agent is in service	-
1055	Info	Protection: agent is starting	Protection: agent is in service	-
1056	Info	Protection: agent is stopping	Protection: agent is in service	-
1057	Info	Protection: agent is stopped	Protection: agent is in service	-
1100	Info	Schedule: shutdown date reached	Schedule: shutdown initiated	-
1101	Info	Schedule: restart date reached	Schedule: restart initiated	-
1300	Info	No UPS connected	Communication recovered (with UPS)	-
1301	Info	UPS not supported	Communication recovered (with UPS)	-

## 6.5.4 With settable severity

Code	Severity	Active message	Non-active message	Advice
1221	Settable	Contact is active ( <i>EMP</i> )	Contact is back to normal ( <i>EMP</i> )	-

## 6.6 System log codes



To retrieve System logs, navigate to Card>>>System logs section and press the **Download System logs** button.



Below codes are the one to be used to add "Exceptions on events notification" on email sending configurations.  
Some zeros maybe added in front of the code when displayed in emails or logs.

### 6.6.1 Critical

Code	Severity	Log message	File
0801000	Alert	User account - admin password reset to default	logAccount.csv
0E00400	Critical	The [selfsign/PKI] signed certificate of the <service> server is not valid	logSystem.csv
0A00700	Error	Network module file system integrity corrupted <f/w: xx.yy.zzzz>	logUpdate.csv
0000D00	Error	Card reboot due to database error	logSystem.csv
0700200	Error	Failed to start execution of script "<script description>". Client not registered. (<script uuid>)	logSystem.csv
0700400	Error	Execution of script "<script description>" failed with return code: <script return code>. (<script uuid>)	logSystem.csv
0700500	Error	Execution of script "<script description>" timeout! (<script uuid>)	logSystem.csv
0700700	Alert	Failed to prepare isolated environment for script execution. Protection service startup is aborted.	logSystem.csv

### 6.6.2 Warning

Code	Severity	Log message	File
0A00200	Warning	Network module upgrade failed <f/w: xx.yy.zzzz>	logUpdate.csv
0A00A00	Warning	Network module bootloader upgrade failed <f/w: xx.yy.zzzz>	logUpdate.csv
0B00500	Warning	RTC battery cell low	logSystem.csv
0E00200	Warning	New [self/PKI] signed certificate [generated/imported] for <service> server	logSystem.csv
0E00300	Warning	The [self/PKI] signed certificate of the <service> server will expires in <X> days	logSystem.csv
0800700	Warning	User account - password expired	logAccount.csv
0800900	Warning	User account- locked	logAccount.csv
0C00100	Warning	Unable to send email: Smtplib server is unknown	logSystem.csv
0C00200	Warning	Unable to send email: Authentication method is not supported	logSystem.csv
0C00300	Warning	Unable to send email: Authentication error	logSystem.csv
0C00500	Warning	Unable to send email: Certificate Authority not recognized	logSystem.csv
0C00600	Warning	Unable to send email: Secure connection required	logSystem.csv
0C00800	Warning	Unable to send email: Unknown error	logSystem.csv
0C00B00	Warning	Unable to send email: Recipient not specified	logSystem.csv

0F01300	Warning	Card reboot due to UPS FW upgrade	logSystem.csv
1000F00	Warning	<feature> settings partial restoration	logSystem.csv
1001000	Warning	<feature> settings restoration error	logSystem.csv
1000C00	Warning	Settings partial restoration	logSystem.csv
1000D00	Warning	Settings restoration error	logSystem.csv

## 6.6.3 Info

Code	Severity	Log message	File
0300D00	Notice	User action - sanitization launched	logSystem.csv
0A00500	Notice	Network module sanitized	logUpdate.csv
0A00900	Notice	Network module bootloader upgrade success <f/w: xx.yy.zzzz>	logUpdate.csv
0A00B00	Notice	Network module bootloader upgrade started <f/w: xx.yy.zzzz>	logUpdate.csv
0A00C00	Notice	Periodic system integrity check started	logUpdate.csv
0B00100	Notice	Time manually changed	logSystem.csv
0B00700	Notice	NTP sever not available <NTP server address>	logSystem.csv
0900100	Notice	Session - opened	logSession.csv
0900200	Notice	Session - closed	logSession.csv
0900300	Notice	Session - invalid token	logSession.csv
0900400	Notice	Session - authentication failed	logSession.csv
0300F00	Notice	User action - network module admin password reset switch activated	logSystem.csv
0E00500	Notice	[Certificate authority/ Client certificate] <id> is added for <service>	logSystem.csv
0E00600	Notice	[Certificate authority/ Client certificate] <id> is revoked for <service>	logSystem.csv
0700100	Info	Start execution of script "<script description>". (<script uuid>)	logSystem.csv
0700300	Info	Execution of script "<script description>" succeeded. (<script uuid>)	logSystem.csv
0700600	Info/Notice/ Error/Debug	<Script execution log message>	logSystem.csv
0800100	Notice	User account - created <user account id>	logAccount.csv
0800200	Notice	User account - deleted <user account id>	logAccount.csv
0800400	Notice	User account - name changed <user account id>	logAccount.csv
0800600	Notice	User account - password changed	logAccount.csv
0800800	Notice	User account- password reset <user account id>	logAccount.csv
0800A00	Notice	User account- unlocked	logAccount.csv
0800B00	Notice	User account - activated <user account id>	logAccount.csv
0800C00	Notice	User account - deactivated <user account id>	logAccount.csv
0800D00	Notice	User account - password rules changed	logAccount.csv
0800E00	Notice	User account - password expiration changed	logAccount.csv
0800F00	Notice	User account - session expiration changed	logAccount.csv
0900D00	Notice	<user> connected into interactive CLI with session id XXXXXX	logSession.csv
0900E00	Notice	<user> disconnected from interactive CLI with session id XXXXXX	logSession.csv
0900F00	Notice	<user> doesn't have access to CLI - CLI session id XXXXXX	logSession.csv

0901000	Notice	<user> connected and executes remote command <command> into the CLI - CLI session id XXXXXX	logSession.csv
0901100	Notice	<user> finished executing remote command <command> into the CLI - CLI session id XXXXXX	logSession.csv
0901200	Notice	<user> connection rejected - CLI session id XXXXXX	logSession.csv
0901300	Notice	<user> disconnected from interactive CLI with session id XXXXXX due to session timeout	logSession.csv
0901400	Notice	<user> disconnected from interactive CLI with session id XXXXXX due to concurrent connection with session id XXXXXX	logSession.csv
0100C00	Notice	Syslog is started	logSystem.csv
0100B00	Notice	Syslog is stopping	logSystem.csv
0100D00	Notice	Network module is booting	logSystem.csv
0100E00	Notice	Network module is operating	logSystem.csv
0100F00	Notice	Network module is starting shutdown sequence	logSystem.csv
0101000	Notice	Network module is ending shutdown sequence	logSystem.csv
0101400	Notice	Network module shutdown requested	logSystem.csv
0101500	Notice	Network module reboot requested	logSystem.csv
0A00100	Info	Network module upgrade success <f/w: xx.yy.zzzz>	logUpdate.csv
0A00300	Info	Network module upgrade started	logUpdate.csv
0A00600	Info	Network module file system integrity OK <f/w: xx.yy.zzzz>	logUpdate.csv
0B00300	Info	Time with NTP synchronized	logSystem.csv
0B00600	Info	Time settings changed	logSystem.csv
0B01100	Info	Time reset to last known date: "date"	logSystem.csv
0C00F00	Info	Test email	
1000100	Info	Settings saving requested	logSystem.csv
1000200	Info	<feature> settings saved	logSystem.csv
1000A00	Info	Settings restoration requested	logSystem.csv
1000E00	Info	<feature> settings restoration success	logSystem.csv
1000B00	Info	Settings restoration success	logSystem.csv
0301500	Notice	Sanitization switch changed	logSystem.csv
0A01600	Notice	Major version downgrade	logUpdate.csv

**Notes:**

1. Event with code 0700600 is used within shutdown script. The severity may vary according to the event context.

## 6.7 SNMP traps

### 6.7.1 Sensor Mib traps

This information is for reference only.

Trap oid : .1.3.6.1.4.1.534.6.8.1.x.x.x	Trap description
.1.3.6.1.4.1.534.6.8.1.1.0.1	Sent whenever the sensor count changes after a discovery or removing from the UI.
.1.3.6.1.4.1.534.6.8.1.1.0.2	Sent whenever one status of each sensor connected changes.
.1.3.6.1.4.1.534.6.8.1.2.0.1	Sent whenever one status of each temperature changes.
.1.3.6.1.4.1.534.6.8.1.3.0.1	Sent whenever one status of each humidity changes.
.1.3.6.1.4.1.534.6.8.1.4.0.1	Sent whenever one status of each digital input alarm changes.

### 6.7.2 Xups Mib traps

This information is for reference only.

Trap oid : .1.3.6.1.4.1.534.1.11.4.1.0.x	Trap message at oid : .1.3.6.1.4.1.534.1.11.3.0
.1.3.6.1.4.1.534.1.11.4.1.0.3	Battery discharging
.1.3.6.1.4.1.534.1.11.4.1.0.4	Battery low
.1.3.6.1.4.1.534.1.11.4.1.0.5	No more on battery
.1.3.6.1.4.1.534.1.11.4.1.0.6	Battery OK
.1.3.6.1.4.1.534.1.11.4.1.0.7	Power overload
.1.3.6.1.4.1.534.1.11.4.1.0.8	Internal failure
.1.3.6.1.4.1.534.1.11.4.1.0.10	Inverter internal failure
.1.3.6.1.4.1.534.1.11.4.1.0.11	Bypass mode
.1.3.6.1.4.1.534.1.11.4.1.0.12	Bypass not available
.1.3.6.1.4.1.534.1.11.4.1.0.13	Load not powered
.1.3.6.1.4.1.534.1.11.4.1.0.14	On battery
.1.3.6.1.4.1.534.1.11.4.1.0.15	Building alarm through input dry contact
.1.3.6.1.4.1.534.1.11.4.1.0.16	Shutdown imminent
.1.3.6.1.4.1.534.1.11.4.1.0.17	No more on bypass
.1.3.6.1.4.1.534.1.11.4.1.0.20	Breaker open
.1.3.6.1.4.1.534.1.11.4.1.0.23	Battery test failed
.1.3.6.1.4.1.534.1.11.4.1.0.26	Communication lost
.1.3.6.1.4.1.534.1.11.4.1.0.30	Sensor contact is active
.1.3.6.1.4.1.534.1.11.4.1.0.31	Sensor contact back to normal
.1.3.6.1.4.1.534.1.11.4.1.0.32	Parallel UPS redundancy lost
.1.3.6.1.4.1.534.1.11.4.1.0.33	Temperature alarm
.1.3.6.1.4.1.534.1.11.4.1.0.34	Battery charger fault
.1.3.6.1.4.1.534.1.11.4.1.0.35	Fan fault
.1.3.6.1.4.1.534.1.11.4.1.0.36	Fuse fault

Trap oid :	Trap message at oid :
.1.3.6.1.4.1.534.1.11.4.1.0.x	.1.3.6.1.4.1.534.1.11.3.0
.1.3.6.1.4.1.534.1.11.4.1.0.42	Sensor temperature is below/above critical threshold
.1.3.6.1.4.1.534.1.11.4.1.0.43	Sensor humidity is below/above critical threshold
.1.3.6.1.4.1.534.1.11.4.1.0.48	Maintenance bypass

## 6.7.3 IETF Mib-2 Ups traps

This information is for reference only.

Trap oid :	Description :
.1.3.6.1.2.1.33.2.0.x	
.1.3.6.1.2.1.33.2.0.1	Sent whenever the UPS transfers on battery, then sent every minutes until the UPS Comes back to AC Input.
.1.3.6.1.2.1.33.2.0.3	Sent whenever an alarm appears. The matching alarm oid is added as binded variables in the table below.
.1.3.6.1.2.1.33.2.0.4	Sent whenever an alarm disappears. The matching alarm oid is added as binded variables in the table below.

Alarm oid at :	Description when trap 3	Description when trap 4
.1.3.6.1.2.1.33.1.6.3.x		
.1.3.6.1.2.1.33.1.6.3.1	Battery test failed	Battery test OK
.1.3.6.1.2.1.33.1.6.3.2	Battery discharging	End of UPS battery discharge
.1.3.6.1.2.1.33.1.6.3.3	Low battery	Battery OK
.1.3.6.1.2.1.33.1.6.3.5	Temperature alarm	Temperature OK
.1.3.6.1.2.1.33.1.6.3.6	Input AC not present	Input AC present
.1.3.6.1.2.1.33.1.6.3.8	Power overload	No power overload
.1.3.6.1.2.1.33.1.6.3.9	Bypass mode	No more on bypass
.1.3.6.1.2.1.33.1.6.3.10	Bypass not available	Bypass available
.1.3.6.1.2.1.33.1.6.3.13	Battery charger fault	Battery charger OK
.1.3.6.1.2.1.33.1.6.3.14	Not powered	Powered (Protected or Not protected)
.1.3.6.1.2.1.33.1.6.3.16	Fan fault	Fan OK
.1.3.6.1.2.1.33.1.6.3.17	Battery fuse fault Rectifier fuse fault Inverter fuse fault	Battery fuse OK Rectifier fuse OK Inverter fuse OK
.1.3.6.1.2.1.33.1.6.3.18	Internal failure	End of internal failure
.1.3.6.1.2.1.33.1.6.3.20	Communication lost	Communication recovered
.1.3.6.1.2.1.33.1.6.3.23	Shutdown imminent	Shutdown canceled

## 6.8 CLI

CLI can be accessed through:

- SSH
- Serial terminal emulation (refer to section [Servicing the Network Management Module>>>Installing the Network Module>>>Accessing the card through serial terminal emulation](#)).

It is intended mainly for automated configuration of the network and time settings of the network card. It can also be used for troubleshooting and remote reboot/reset of the network interface in case the web user interface is not accessible.

**Warning:** Changing network parameters may cause the card to become unavailable remotely. If this happens it can only be reconfigured locally through USB.

## 6.8.1 Commands available

You can see this list anytime by typing in the CLI:

```
?
```

## 6.8.2 Contextual help

You can see this help anytime by typing in the CLI:

```
help
```

### CONTEXT SENSITIVE HELP

[?] - Display context sensitive help. This is either a list of possible command completions with summaries, or the full syntax of the current command. A subsequent repeat of **this** key, when a command has been resolved, will display a detailed reference.

### AUTO-COMPLETION

The following keys both perform auto-completion **for** the current command line. If the command prefix is not unique then the bell will ring and a subsequent repeat of the key will display possible completions.

[enter] - Auto-completes, syntax-checks then executes a command. If there is a syntax error then offending part of the command line will be highlighted and explained.

[space] - Auto-completes, or **if** the command is already resolved inserts a space.

### MOVEMENT KEYS

[CTRL-A] - Move to the start of the line  
 [CTRL-E] - Move to the end of the line.  
 [up] - Move to the previous command line held in history.  
 [down] - Move to the next command line held in history.  
 [left] - Move the insertion point left one character.  
 [right] - Move the insertion point right one character.

### DELETION KEYS

[CTRL-C] - Delete and abort the current line  
 [CTRL-D] - Delete the character to the right on the insertion point.  
 [CTRL-K] - Delete all the characters to the right of the insertion point.  
 [CTRL-U] - Delete the whole line.  
 [backspace] - Delete the character to the left of the insertion point.

### ESCAPE SEQUENCES

!! - Substitute the last command line.  
 !N - Substitute the Nth command line (absolute as per 'history' command)  
 !-N - Substitute the command line entered N lines before (relative)

## 6.8.3 get release info

### 6.8.3.1 Description

Displays certain basic information related to the firmware release.

### 6.8.3.2 Access

- Viewer
- Operator
- Administrator

### 6.8.3.3 Help

```
get_release_info
-d Get current release date
-s Get current release sha1
-t Get current release time
-v Get current release version number
```

## 6.8.4 history

### 6.8.4.1 Description

Displays recent commands executed on the card.

### 6.8.4.2 Access

- Viewer
- Operator
- Administrator

### 6.8.4.3 Help

```
history
<cr> Display the current session's command line history (by default display
last 10 commands)
<Unsigned integer> Set the size of history list (zero means unbounded). Example 'history
6' display the 6 last command
```

## 6.8.5 ldap-test

### 6.8.5.1 Description

Ldap-test help to troubleshoot LDAP configuration issues or working issues.



## 6.8.5.2 Access

- Administrator

## 6.8.5.3 Help

```

Usage: ldap-test <command> [OPTION]...
Test LDAP configuration.

Commands:
ldap-test -h, --help, Display help page

ldap-test --checkusername <username> [--primary|--secondary] [-v]
Check if the user can be retrieve from the LDAP server
<username>      Remote username to test
--primary       Force the test to use primary server (optional)
--secondary     Force the test to use secondary server (optional)
-v,--verbose    Print the exchanges with LDAP server (optional)

ldap-test --checkauth <username> [--primary|--secondary] [-v]
Check if remote user can login to the card
<username>      Remote username to test
-p,--primary    Force the test to use primary server (optional)
-s,--secondary Force the test to use secondary server (optional)
-v,--verbose    Print the exchanges with LDAP server (optional)

ldap-test --checkmappedgroups [--primary|--secondary] [-v]
Check LDAP mapping
-p,--primary    Force the test to use primary server (optional)
-s,--secondary Force the test to use secondary server (optional)
-v,--verbose    Print the exchanges with LDAP server (optional)

Quick guide for testing:

In case of issue with LDAP configuration, we recommend to verify the
configuration using the commands in the following order:

1. Check user can be retrieve on the LDAP server
   ldap-test --checkusername <username>

2. Check that your remote group are mapped to the good profile
   ldap-test --checkmappedgroups

3. Check that the user can connect to the card
   ldap-test --checkauth <username>

```

## 6.8.6 logout

### 6.8.6.1 Description

Logout the current user.

## 6.8.6.2 Access

- Viewer
- Operator
- Administrator

## 6.8.6.3 Help

```
logout  
<cr> logout the user
```

## 6.8.7 maintenance

### 6.8.7.1 Description

Creates a maintenance report file which may be handed to the technical support.

### 6.8.7.2 Access

- Administrator

### 6.8.7.3 Help

```
maintenance  
    <cr> Create maintenance report file.  
    -h, --help Display help page
```

## 6.8.8 netconf

### 6.8.8.1 Description

Tools to display or change the network configuration of the card.

### 6.8.8.2 Access

- Viewer (read-only)
- Operator (read-only)
- Administrator

### 6.8.8.3 Help

For Viewer and Operator profiles:

```
netconf -h
Usage: netconf [OPTION]...
Display network information and change configuration.

-h, --help          display help page
-l, --lan           display Link status and MAC address
-4, --ipv4         display IPv4 Mode, Address, Netmask and Gateway
-6, --ipv6         display IPv6 Mode, Addresses and Gateway
-d, --domain       display Domain mode, FQDN, Primary and Secondary DNS
```

For Administrator profile:

```

netconf -h
Usage: netconf [OPTION]...
Display network information and change configuration.
-h, --help          display help page
-l, --lan           display Link status and MAC address
-d, --domain       display Domain mode, FQDN, Primary and Secondary DNS
-4, --ipv4         display IPv4 Mode, Address, Netmask and Gateway
-6, --ipv6         display IPv6 Mode, Addresses and Gateway
Set commands are used to modify the settings.
-s, --set-lan <link speed>
  Link speed values:
  auto             Auto negotiation
  10hf             10 Mbps - Half duplex
  10ff             10 Mbps - Full duplex
  100hf            100 Mbps - Half duplex
  100ff            100 Mbps - Full duplex
  1000ff           1.0 Gbps - Full duplex
-f, --set-domain hostname <hostname>    set custom hostname
-f, --set-domain <mode>
  Mode values:
  - set custom Network address, Netmask and Gateway:
    manual <domain name> <primary DNS> <secondary DNS>
  - automatically set Domain name, Primary and Secondary DNS
    dhcp
-i, --set-ipv4 <mode>
  Mode values:
  - set custom Network address, Netmask and Gateway
    manual <network> <mask> <gateway>
  - automatically set Network address, Netmask and Gateway
    dhcp
-x, --set-ipv6 <status>
  Status values:
  - enable IPv6
    enable
  - disable IPv6
    disable
-x, --set-ipv6 <mode>
  Mode values:
  - set custom Network address, Prefix and Gateway
    manual <network> <prefix> <gateway>
  - automatically set Network address, Prefix and Gateway
    router

Examples of usage:
-> Display Link status and MAC address
netconf -l
-> Set Auto negotiation to Link
netconf --set-lan auto
-> Set custom hostname
netconf --set-domain hostname ups-00-00-00-00-00-00
-> Set Address, Netmask and Gateway
netconf --set-ipv4 manual 192.168.0.1 255.255.255.0 192.168.0.2
-> Disable IPv6

```

## 6.8.8.4 Examples of usage

```

-> Display Link status and MAC address
    netconf -l
-> Set Auto negotiation to Link
    netconf -s auto
-> Set custom hostname
    netconf -f hostname ups-00-00-00-00-00-00
-> Set Adres, Netmask and Gateway
    netconf -i manual 192.168.0.1 255.255.255.0 192.168.0.2
-> Disable IPv6
    netconf -6 disable

```

## 6.8.9 ping and ping6

### 6.8.9.1 Description

Ping and ping6 utilities are used to test network connection.

### 6.8.9.2 Access

- Administrator

### 6.8.9.3 Help

#### ping

The ping utility uses the ICMP protocol's mandatory ECHO\_REQUEST datagram to elicit an ICMP ECHO\_RESPONSE from a host or gateway. ECHO\_REQUEST datagrams ('`pings'`) have an IP and ICMP header, followed by a ``struct timeval'' and then an arbitrary number of ``pad'' bytes used to fill out the packet.

```

-c          Specify the number of echo requests to be sent
-h          Specify maximum number of hops
<Hostname or IP> Host name or IP address

```

#### ping6

The ping6 utility uses the ICMP protocol's mandatory ECHO\_REQUEST datagram to elicit an ICMP ECHO\_RESPONSE from a host or gateway. ECHO\_REQUEST datagrams ('`pings'`) have an IP and ICMP header, followed by a ``struct timeval'' and then an arbitrary number of ``pad'' bytes used to fill out the packet.

```

-c          Specify the number of echo requests to be sent
<IPv6 address> IPv6 address

```

## 6.8.10 reboot

### 6.8.10.1 Description

Tool to Reboot the card.

## 6.8.10.2 Access

- Administrator

## 6.8.10.3 Help

```
Usage: reboot [OPTION]
      <cr>                               Reboot the card
      --help                             Display help
      --withoutconfirmation               Reboot the card without confirmation
```

## 6.8.11 save\_configuration | restore\_configuration

### 6.8.11.1 Description

save\_configuration and restore\_configuration are using JSON format to save and restore certain part of the configuration of the card.

### 6.8.11.2 Access

- Administrator

### 6.8.11.3 Help

```
save_configuration -h
save_configuration: print the card configuration in JSON format to standard output.
```

```
restore_configuration -h
restore_configuration: restore the card configuration from a JSON-formatted standard input.
```

### 6.8.11.4 Examples of usage

#### 6.8.11.4.1 From a linux host:

**Save over SSH:** sshpass -p \$PASSWORD ssh \$USER@\$CARD\_ADDRESS save\_configuration -p \$PASSPHRASE > \$FILE

**Restore over SSH:** cat \$FILE | sshpass -p \$PASSWORD ssh \$USER@\$CARD\_ADDRESS restore\_configuration -p \$PASSPHRASE

#### 6.8.11.4.2 From a Windows host:

**Save over SSH:** plink \$USER@\$CARD\_ADDRESS -pw \$PASSWORD -batch save\_configuration -p \$PASSPHRASE > \$FILE

**Restore over SSH:** type \$FILE | plink \$USER@\$CARD\_ADDRESS -pw \$PASSWORD -batch restore\_configuration -p \$PASSPHRASE  
(Require plink tools from putty)

Where:

- \$USER is user name (the user shall have administrator profile)
- \$PASSWORD is the user password
- \$PASSPHRASE is any passphrase to encrypt/decrypt sensible data.
- \$CARD\_ADDRESS is IP or hostname of the card
- \$FILE is a path to the JSON file (on your host computer) where the configuration is saved or restored.

## 6.8.12 sanitize

### 6.8.12.1 Description

Sanitize command to return card to factory reset configuration.

### 6.8.12.2 Access

- Administrator

### 6.8.12.3 Help

```
sanitize
-h, --help          Display help page
--withoutconfirmation Do factory reset of the card without confirmation
<cr>                Do factory reset of the card
```

## 6.8.13 ssh-keygen

### 6.8.13.1 Description

Command used for generating the ssh keys.

### 6.8.13.2 Access

- Administrator

### 6.8.13.3 Help

```
ssh-keygen
-h, --help  Display help
<cr>       Renew SSH keys
```

## 6.8.14 time

### 6.8.14.1 Description

Command used to display or change time and date.

### 6.8.14.2 Access

- Viewer (read-only)
- Operator (read-only)
- Administrator

### 6.8.14.3 Help

For Viewer and Operator profiles:

```
time -h
Usage: time [OPTION]...
Display time and date.

-h, --help      display help page
-p, --print     display date and time in YYYYMMDDhhmmss format
```

For Administrator profile:

```
time -h
Usage: time [OPTION]...
Display time and date, change time and date.
-h, --help      display help page
-p, --print     display date and time in YYYYMMDDhhmmss format
-s, --set <mode>
Mode values:
- set date and time (format YYYYMMDDhhmmss)
  manual <date and time>
- set preferred and alternate NTP servers
  ntpmanual <preferred server> <alternate server>
- automatically set date and time
  ntpauto
Examples of usage:
-> Set date 2017-11-08 and time 22:00
   time --set manual 201711082200
-> Set preferred and alternate NTP servers
   time --set ntpmanual fr.pool.ntp.org de.pool.ntp.org
```

#### 6.8.14.4 Examples of usage

```
-> Set date 2017-11-08 and time 22:00
   time --set manual 201711082200
-> Set preferred and alternate NTP servers
   time --set ntpmanual fr.pool.ntp.org de.pool.ntp.org
```

### 6.8.15 traceroute and traceroute6

#### 6.8.15.1 Description

Traceroute and traceroute6 utilities are for checking the configuration of the network.

#### 6.8.15.2 Access

- Administrator

#### 6.8.15.3 Help

```
traceroute
-h          Specify maximum number of hops
<Hostname or IP> Remote system to trace
```



```
traceroute6
-h          Specify maximum number of hops
<IPv6 address> IPv6 address
```

## 6.8.16 whoami

### 6.8.16.1 Description

whoami displays current user information:

- Username
- Profile
- Realm

### 6.8.16.2 Access

- Viewer
- Operator
- Administrator

## 6.8.17 email-test

### 6.8.17.1 Description

mail-test sends test email to troubleshoot SMTP issues.

### 6.8.17.2 Access

- Operator
- Administrator

### 6.8.17.3 Help

```
Usage: email-test <command> ...
Test SMTP configuration.

Commands:
email-test -h, --help, Display help page

email-test -r, --recipient <recipient_address>
Send test email to the
<recipient_address>      Email address of the recipient
```

## 6.8.18 systeminfo\_statistics

### 6.8.18.1 Description

Displays the following system information usage:

1. CPU
  - a. usage : %
  - b. upSince : date since the system started

2. Ram
  - a. total: MB
  - b. free: MB
  - c. used: MB
  - d. tmpfs: temporary files usage (MB)
3. Flash
  - a. user data
    - i. total: MB
    - ii. free: MB
    - iii. used: MB

## 6.8.18.2 Access

- Viewer
- Operator
- Administrator

## 6.8.18.3 Help

```
systeminfo_statistics
    Display systeminfo statistics

-h, --help    Display the help page.
```

## 6.8.19 certificates.

### 6.8.19.1 Description

Allows to manage certificates through the CLI.

### 6.8.19.2 Access

- Administrator

### 6.8.19.3 Help

```
certificates <target> <action> <service_name>
<target> :
    - local
<action> :
    - print: provides a given certificate detailed information.
    - revoke: revokes a given certificate.
    - export: returns a given certificate contents.
    - import: upload a given certificate for the server CSR. This will replace
the CSR with the certificate given.
    - csr: get the server CSR contents. This will create the CSR if not already
existing.
<service_name>: mqtt/syslog/webserver
```

## 6.8.19.4 Examples of usage

### 6.8.19.4.1 From a linux host:

**print over SSH:** sshpass -p \$PASSWORD ssh \$USER@\$CARD\_ADDRESS certificates local print \$SERVICE\_NAME

**revoke over SSH:** sshpass -p \$PASSWORD ssh \$USER@\$CARD\_ADDRESS certificates local revoke \$SERVICE\_NAME

**export over SSH:** sshpass -p \$PASSWORD ssh \$USER@\$CARD\_ADDRESS certificates local export \$SERVICE\_NAME

**import over SSH:** cat \$FILE | sshpass -p \$PASSWORD ssh \$USER@\$CARD\_ADDRESS certificates local import \$SERVICE\_NAME

**csr over SSH:** sshpass -p \$PASSWORD ssh \$USER@\$CARD\_ADDRESS certificates local csr mqtt

### 6.8.19.4.2 From a Windows host: (plink tools from putty is required)

**print over SSH:** plink \$USER@\$CARD\_ADDRESS -pw \$PASSWORD -batch certificates local print \$SERVICE\_NAME

**revoke over SSH:** plink \$USER@\$CARD\_ADDRESS -pw \$PASSWORD -batch certificates local revoke \$SERVICE\_NAME

**export over SSH:** plink \$USER@\$CARD\_ADDRESS -pw \$PASSWORD -batch certificates local export \$SERVICE\_NAME

**import over SSH:** type \$FILE | plink \$USER@\$CARD\_ADDRESS -pw \$PASSWORD -batch certificates local import \$SERVICE\_NAME

**csr over SSH:** plink \$USER@\$CARD\_ADDRESS -pw \$PASSWORD -batch certificates local csr mqtt

### 6.8.19.4.3 Where:

- \$USER is user name (the user shall have administrator profile)
- \$PASSWORD is the user password
- \$PASSPHRASE is any passphrase to encrypt/decrypt sensible data.
- \$CARD\_ADDRESS is IP or hostname of the card
- \$FILE is a certificate file
- \$SERVICE\_NAME is the name one of the following services : mqtt / syslog / webserver.

## 6.9 Legal information

This Network Module includes software components that are either licensed under various open source license, or under a proprietary license.

For more information, see to the legal Information link from the main user interface in the footer.

### 6.9.1 Availability of Source Code

The source code of open source components that are made available by their licensors may be obtained upon written express request by contacting [network-m2-opensource@Eaton.com](mailto:network-m2-opensource@Eaton.com). Eaton reserves the right to charge minimal administrative costs, in compliance with the terms of the underlying open source licenses, when the situation requires.

### 6.9.2 Notice for Open Source Elements

This product includes software released under BSD or Apache v2 licenses, and developed by various projects, peoples and entities, such as, but not limited to:

- \* the Regents of the University of California, Berkeley and its contributors,
- \* the OpenEvidence Project,
- \* Oracle and/or its affiliates,
- \* Mike Bostock,
- \* JS Foundation and other contributors,
- \* 2011-2014 Novus Partners, Inc.

This product includes software developed by the OpenSSL Project for use in the OpenSSL Toolkit. ([www.openssl.org/](http://www.openssl.org/)).

This product includes cryptographic software written by Eric Young ([eay@cryptsoft.com](mailto:eay@cryptsoft.com)).

This product includes software released under MIT license, and developed by various projects, peoples and entities, such as, but not limited to:

- \* Google, Inc.,
- \* the AngularUI Team
- \* Lucas Galfasó
- \* nerv
- \* Angular
- \* Konstantin Skipor
- \* Filippo Oretti, Dario Andrei
- \* The angular-translate team and Pascal Precht,
- \* Twitter, Inc.
- \* Zeno Rocha
- \* Kristopher Michael Kowal and contributors
- \* JS Foundation and other contributors
- \* Jonathan Hieb
- \* Mike Grabski
- \* Sachin N.

This product includes contents released under Creative Commons Attribution 4.0, Creative Commons Attribution-ShareAlike 3.0 Unported and SIL Open Font License licenses, and created by:

- \* IcoMoon
- \* Dave Gandy
- \* Stephen Hutchings and the Typicons team.

In order to access the complete and up to date copyright information, licenses, and legal disclaimers, see the Legal Information pages, available from the HTML user interface of the present product.

### **6.9.3 Notice for our proprietary (i.e. non-Open source) elements**

Copyright © 2019 Eaton. This firmware is confidential and licensed under Eaton Proprietary License (EPL or EULA).

This firmware is not authorized to be used, duplicated, or disclosed to anyone without the prior written permission of Eaton.

Limitations, restrictions and exclusions of the Eaton applicable standard terms and conditions, such as its EPL and EULA, apply.

## 6.10 Acronyms and abbreviations

**AC:** Alternating current.

**AVR:** Automatic Voltage Regulation provides stable voltage to keep equipment running in the optimal range.

**BMS:** A Battery Management System is any electronic system that manages li-ion battery.

**BOM:** In Syslog, placing an encoded Byte Order Mark at the start of a text stream can indicate that the text is Unicode and identify the encoding scheme used.

**CA:** Certificate Authority

**CLI:** Command Line Interface.

Aim is to interact with the Network Module by using commands in the form of successive lines of text (command lines).

**CSR:** Certificate Signing Request

**DC:** Direct current.

**DN:** Distinguished Name (LDAP).

**DHCPv6:** The Dynamic Host Configuration Protocol version 6 is a network protocol for configuring Internet Protocol version 6 (IPv6) hosts with IP addresses, IP prefixes and other configuration data required to operate in an IPv6 network. It is the IPv6 equivalent of the Dynamic Host Configuration Protocol for IPv4.

**DNS:** The Domain Name System is a hierarchical decentralized naming system for computers, services, or other resources connected to the Internet or a private network.

**DST:** The daylight saving time.**EMP:** Environmental monitoring probe**GID:** Group Identifier is a numeric value used to represent a specific group (LDAP).**HTTPS:** HTTPS consists of communication over Hypertext Transfer Protocol (HTTP) within a connection encrypted by Transport Layer Security (TLS).

**IPP:** Intelligent Power Protector is a web-based application that enables administrators to manage an UPS from a browser-based management console. Administrators can monitor, manage, and control a single UPS locally and remotely. A familiar browser interface provides secure access to the UPS Administrator Software and UPS Client Software from anywhere on the network. Administrators may configure power failure settings and define UPS load segments for maximum uptime of critical servers. The UPS can also be configured to extend runtimes for critical devices during utility power failures. For most UPSs, the receptacles on the rear panel are divided into one or more groups, called load segments, which can be controlled independently. By shutting down a load segment that is connected to less critical equipment, the runtime for more critical equipment is extended, providing additional protection.

**IPv4:** Internet Protocol version 4 is the fourth version of the Internet Protocol (IP).

**IPv6:** Internet Protocol version 6 is the most recent version of the Internet Protocol (IP).

**JSON:** JavaScript Object Notation is an open-standard file format that uses human-readable text to transmit data objects consisting of attribute–value pairs and array data types.

**kVA:** kilovolt-ampere

**LAN:** A LAN is a local area network, a computer network covering a small local area, such as a home or office.

**LDAP:** The Lightweight Directory Access Protocol is an industry standard application protocol for accessing and maintaining distributed directory information services over an Internet Protocol.

**MAC:** A media access control address of a computer is a unique identifier assigned to network interfaces for communications at the data link layer of a network segment.

**MIB:** A management information base is a database used for managing the entities in a communication network. Most often associated with the Simple Network Management Protocol (SNMP).

**NTP:** Network Time Protocol is a networking protocol for clock synchronization between computer systems.

**P/N:** Part number.

**RTC:** Real time clock**S/N:** Serial number.

**SMTP:** Simple Mail Transfer Protocol is an Internet standard for electronic mail (email) transmission.

**SNMP:** Simple Network Management Protocol is an Internet-standard protocol for collecting and organizing information about managed devices on IP networks and for modifying that information to change device behavior.

**SSH:** Secure Shell is a cryptographic network protocol for operating network services securely over an unsecured network.

**SSL:** Secure Sockets Layer, is a cryptographic protocol used for network traffic.**TLS:** Transport Layer Security is cryptographic protocol that provide communications security over a computer network.

**TFTP:** Trivial File Transfer Protocol is a simple lockstep File Transfer Protocol which allows a client to get a file from or put a file onto a remote host.

**UID:** User identifier (LDAP).

**UTC:** Coordinated Universal Time is the primary time standard by which the world regulates clocks and time.

**UPS:** An uninterruptible power supply is an electrical apparatus that provides emergency power to a load when the input power source or mains power fails.

A UPS is typically used to protect hardware such as computers, data centers, telecommunication equipment or other electrical equipment where an unexpected power disruption could cause injuries, fatalities, serious business disruption or data loss.



# 7 Troubleshooting

## 7.1 Action not allowed in Control/Schedule/Power outage policy

### 7.1.1 Symptom

Below message is displayed when you access the Control, Schedule or Power outage policy page.

This action is not allowed by the UPS.

To enable it, please refer to the user manual of the UPS and its instructions on how to configure the UPS settings and allow remote commands.

### 7.1.2 Possible Cause

1- Remote commands are not allowed due to the UPS configuration (see the action below)

2- The UPS does not support remote commands.

### 7.1.3 Action

Refer to the UPS user manual and its instruction on how to configure the UPS settings and allow remote commands.

Example: UPS menu Settings>>>ON/OFF settings>>>Remote command>>>Enable.

## 7.2 Client server is not restarting

### 7.2.1 Symptom

Utility power has been restored, the UPS and its load segments are powered on, but the Client server does not restart.

### 7.2.2 Possible Cause

The "Automatic Power ON" server setup setting might be disabled.

### 7.2.3 Action

In the server system BIOS, change the setting for Automatic Power ON to "Enabled".

## 7.3 EMP detection fails at discovery stage

In the Network Module, in Card>>>Commissioning, EMPs are missing in the Sensor commissioning table.

### 7.3.1 Symptom #1

The EMPs green RJ45 LED (FROM DEVICE) is not ON.

#### 7.3.1.1 Possible causes

The EMPs are not powered by the Network module.



### 7.3.1.2 Action #1-1

Launch again the discovery, if it is still not ok, go to Action #1-2.

### 7.3.1.3 Action #1-2

1- Check the EMPs connection and cables.

Refer to the sections [Servicing the EMP>>>Installing the EMP>>>Cabling the first EMP to the device](#) and [Servicing the EMP>>>Installing the EMP>>>Daisy chaining 3 EMPs](#).

2- Disconnect and reconnect the USB to RS485 cable.

3- Launch the discovery, if it is still not ok, go to Action #1-3.

### 7.3.1.4 Action #1-3

1- Reboot the Network module.

2- Launch the discovery.

## 7.3.2 Symptom #2

The EMPs orange RJ45 LEDs are not blinking.

### 7.3.2.1 Possible causes

C#1: the EMP address switches are all set to 0.

C#2: the EMPs are daisy chained, the Modbus address is the same on the missing EMPs.

### 7.3.2.2 Action #2-1

1- Change the address of the EMPs to have different address and avoid all switches to 0.

Refer to the section [Servicing the EMP>>>Defining EMPs address and termination>>>Manual addressing](#).

2- Disconnect and reconnect the USB to RS485 cable. The address change is only taken into account after an EMP power-up.

3- Launch the discovery, if it is still not ok, go to Action #2-2.

### 7.3.2.3 Action #2-2

1- Reboot the Network module.

Refer to the section [Card>>>Administration>>>Reboot](#).

2- Launch the discovery.

## 7.4 How do I log in if I forgot my password?

### 7.4.1 Action

- Ask your administrator for password initialization.
- If you are the main administrator, your password can be reset manually by following steps described in the [Recovering main administrator password](#).

## 7.5 Card wrong timestamp leads to "Full acquisition has failed" error message on IPM/IPP

### 7.5.1 Symptoms:

IPM/IPP shows the error message "The full data acquisition has failed" even if the credentials are correct.

### 7.5.2 Possible cause:

The Network module timestamp is not correct.  
Probably the MQTT certificate is not valid at Network-M2 date.

### 7.5.3 Action:

Set the right date, time and timezone. If possible, use a NTP server

## 7.6 IPP/IPM is not able to communicate with the Network module

### 7.6.1 Symptoms

- In the Network Module, in Protection>>>Agents list>>>Agents list, agent is showing "**Lost**" as a status.
- In the Network Module, in Settings>>>Certificates>>>Trusted remote certificates, the status of the Protected applications (MQTT) is showing "**Not valid yet**".
- IPP/IPM shows "The authentication has failed", "The notifications reception encountered error".

### 7.6.2 Possible cause

The IPP/IPM certificate is not yet valid for the Network Module.

Certificates of IPP/IPM and the Network Module are not matching so that authentication and encryption of connections between the Network Module and the shutdown agents is not working.

### 7.6.3 Setup

IPP/IPM is started.

Network module is connected to the UPS and to the network.

### 7.6.4 Action #1

Check if the IPP/IPM certificate validity for the Network Module.

**STEP 1:** Connect to the Network Module

- On a network computer, launch a supported web browser. The browser window appears.
- In the Address/Location field, enter: <https://xxx.xxx.xxx.xxx/> where xxx.xxx.xxx.xxx is the static IP address of the Network Module.
- The log in screen appears.
- Enter the user name in the User Name field.
- Enter the password in the Password field.
- Click **Sign In**. The Network Module web interface appears.

**STEP 2:** Navigate to **Settings/Certificates** page

**STEP 3:** In the **Trusted remote certificates** section, check the status of the **Protected applications (MQTT)**.

If it is **"Valid"** go to Action#2 STEP 2, if it is **"Not yet valid"**, time of the need to be synchronized with IPP/IPM.

**STEP 4:** Synchronize the time of the Network Module with IPP/IPM and check that the status of the **Protected applications (MQTT)** is now valid.

Communication will then recover, if not go to Action#2 STEP 2.

## 7.6.5 Action #2

Pair agent to the Network Module with automatic acceptance (recommended in case the installation is done in a secure and trusted network).



For manual pairing (maximum security), go to [Servicing the Network Management Module>>>Pairing agent to the Network Module](#) section and then go to STEP 2, item 1.

**STEP 1:** Connect to the Network Module.

- On a network computer, launch a supported web browser. The browser window appears.
- In the Address/Location field, enter: `https://xxx.xxx.xxx.xxx/` where `xxx.xxx.xxx.xxx` is the static IP address of the Network Module.
- The log in screen appears.
- Enter the user name in the User Name field.
- Enter the password in the Password field.
- Click **Sign In**. The Network Module web interface appears.

**STEP 2:** Navigate to **Protection/Agents list** page.

**STEP 3:** In the **Pairing with shutdown agents** section, select the time to accept new agents and press the **Start** button and **Continue**. During the selected timeframe, new agent connections to the Network Module are automatically trusted and accepted.

**STEP 4: Action on the agent (IPP/IPM)** while the time to accepts new agents is running on the Network Module

Remove the Network module certificate file(s) `*.0` that is (are) located in the folder `Eaton\IntelligentPowerProtector\configs\tls`.

## 7.7 LDAP configuration/commissioning is not working

Refer to the section [Servicing the Network Management Module>>>Commissioning/Testing LDAP](#).

## 7.8 Password change in My preferences is not working

### 7.8.1 Symptoms

The password change shows **"Invalid credentials"** when I try to change my password in My preferences menu.

### 7.8.2 Possible cause

The password has already been changed once within a day period.

### 7.8.3 Action

Let one day between your last password change and retry.

## 7.9 SNMPv3 password management issue with Save and Restore

### 7.9.1 Affected FW versions

This issue affects SNMP **configuration** done on versions prior to 1.7.0 when applied to versions 1.7.0 or above.

### 7.9.2 Symptom

SNMPv3 connectivity is not properly working after a restore settings on a 1.7.0 version or above.

### 7.9.3 Cause

The SNMPv3 was **configured** prior to 1.7.0.

In that case, SNMPv3 configuration is not well managed by the Save and by the Restore settings.

### 7.9.4 Action

**Reconfigure** your SNMPv3 users and passwords on versions 1.7.0 or above and Save the settings.

The SNMPv3 configuration can then be Restored.

## 7.10 The Network Module fails to boot after upgrading the firmware

### 7.10.1 Possible Cause

The IP address has changed.

**Note:** If the application is corrupt, due to an interruption while flashing the firmware for example, the boot will be done on previous firmware.

### 7.10.2 Action

Recover the IP address and connect to the card.

## 7.11 Web user interface is not up to date after a FW upgrade

### 7.11.1 Symptom

After an upgrade:

- The Web interface is not up to date
- New features of the new FW are not displayed

#### 7.11.1.1 Possible causes

The browser is displaying the Web interface through the cache that contains previous FW data.

#### 7.11.1.2 Action

Empty the cache of your browser using F5 or CTRL+F5.

